

WILLIAMS SONOMA

HOME

Siena Pressed Glass Globe Brass Assembly and Installation Instructions

CAUTION:

- **BEFORE INSTALLING FIXTURE, MAKE SURE THE POWER TO THE CIRCUIT IS TURNED OFF AT THE MAIN FUSE BOX / CIRCUIT BREAKER UTILITY BOX.**

Important Safety Instructions:

- These instructions are provided for your safety. It is very important that they are read carefully and completely before beginning the assembly and installation of this lighting fixture.
- We strongly recommend that a professional electrician install all direct wire fixtures.
- THIS PRODUCT MUST BE INSTALLED IN ACCORDANCE WITH THE APPLICABLE INSTALLATION CODES BY A PERSON FAMILIAR WITH THE CONSTRUCTION AND OPERATION OF THE PRODUCT AND THE HAZARDS INVOLVED.
- The lighting fixture is meant for indoor use. It must be connected only to 3-wire, single-phase electrical supply systems (provided with Ground wire or equivalent protection system).
- The weight of this lighting fixture exceeds 50 pounds and must be installed using an outlet box approved for up to 100 pounds lighting fixture load.
- For your safety, it is strongly recommended that two people install the lighting fixture.
- This fixture has been rated for up to eight (8) **40-Watt maximum TYPE B standard (candelabra) incandescent light bulbs** (not included) or eight (8) **9-Watt compact fluorescent light bulbs** (not included). To avoid the risk of fire, do not exceed the recommended lamp wattage.
- The lighting fixture is meant for indoor use, DRY LOCATIONS ONLY.
- **Save these instructions.**

WARNING:

- **To reduce the risk of fire, electrical shock or personal injury, always turn off light fixture and allow it to cool prior to replacing light bulb.**
- **Do not touch bulb when fixture is turned on. Do not look directly at lit bulb.**
- **Keep flammable materials away from lit bulb.**

Pre-assembly:

- Remove all parts and hardware from box along with any plastic protective packaging.
- Do not discard any contents until after assembly is complete to avoid accidentally discarding small parts or hardware.
- For your safety and convenience, assembly by two people is recommended.

TOOLS REQUIRED (not included):

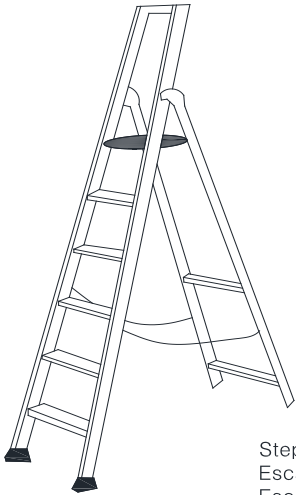
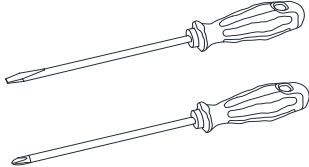
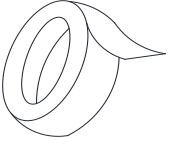
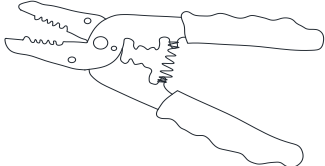
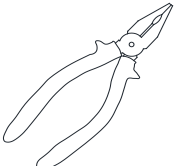
 <p>Step Ladder Escabeau Escalera</p>	 <p>Phillips Head, Flat Blade Screwdrivers Tournevis à tête Phillips et à tête plate Destornilladores Cabeza Phillips y Destornilladores Cabeza Plana</p>	 <p>Electrical tape Ruban isolant Cinta Electrica.</p>
	 <p>Wire Cutter/Stripper Pince coupe-fil/ à dénudé Cortador de Cable</p>	 <p>Plier Pince Alicates</p>

Parts Included:

- (B) Green Ground Screw (1)
- (D) Canopy (1)
- (E) Hanging Loop (1)
- (F) Mounting Plate (1)
- (G) Closable Links with Screw Caps (1)
- (H) Canopy Nut (1)
- (I) Closable Links with Screw Caps (1)
- (J) Fixture Loop (1)
- (K) Metal Rods with Glass Dish (80)
- (M) Sockets (8)
- (L) Fixture Ball (1)
- (N) Chain (1)

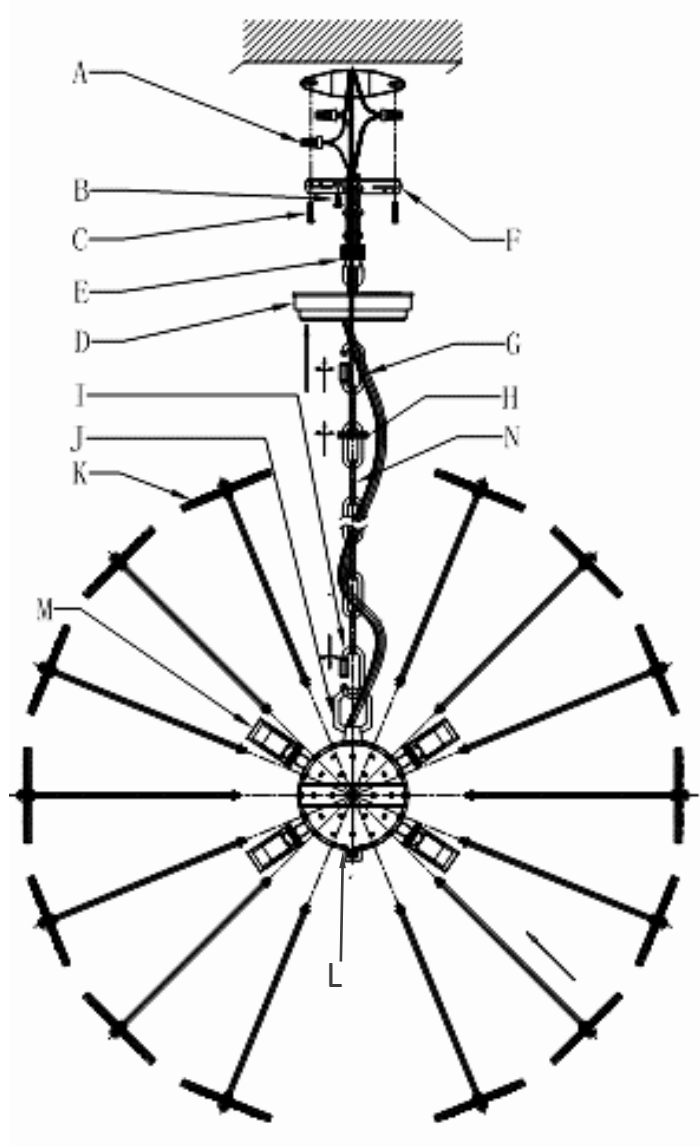

Hardware Enclosed:

- (A) Plastic Wire Nut Connectors (3)
- (C) Mounting Screw (2)

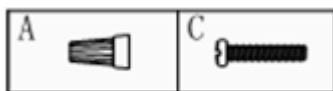

To adjust the suspension length of the fixture:

1. Note: The adjustment or shortening of the lighting fixture's suspension length is only needed if the factory set chain length is not appropriate for your installation. We recommend that you adjust the chain to the proper desired length before cutting the electrical cord. Determine the lighting fixture suspension length from the ceiling for the product installation, allowing the extra cord length for the outlet junction box wire connections as noted below.
2. (See A1) If needed, pull out the fixtures 2 wire power cord and bare ground wire woven through the Chain (N).

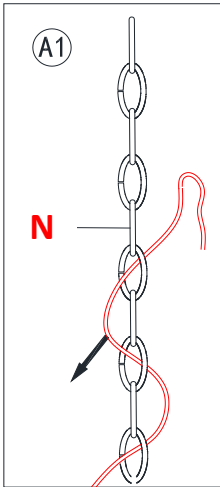

3. (See A2 & A3) The chain length may be shortened from either end. Use two pairs of pliers to gently pry the link apart along a split-line formed in each link so that a space is created large enough for the link to be removed from the remaining chain. Use a cloth or folded piece of paper between the pliers and the link to protect the finish of the link during bending. Once the Chain (N) is at the desired length, reattach the Chain (N) as shown in the diagram below. (See A4)

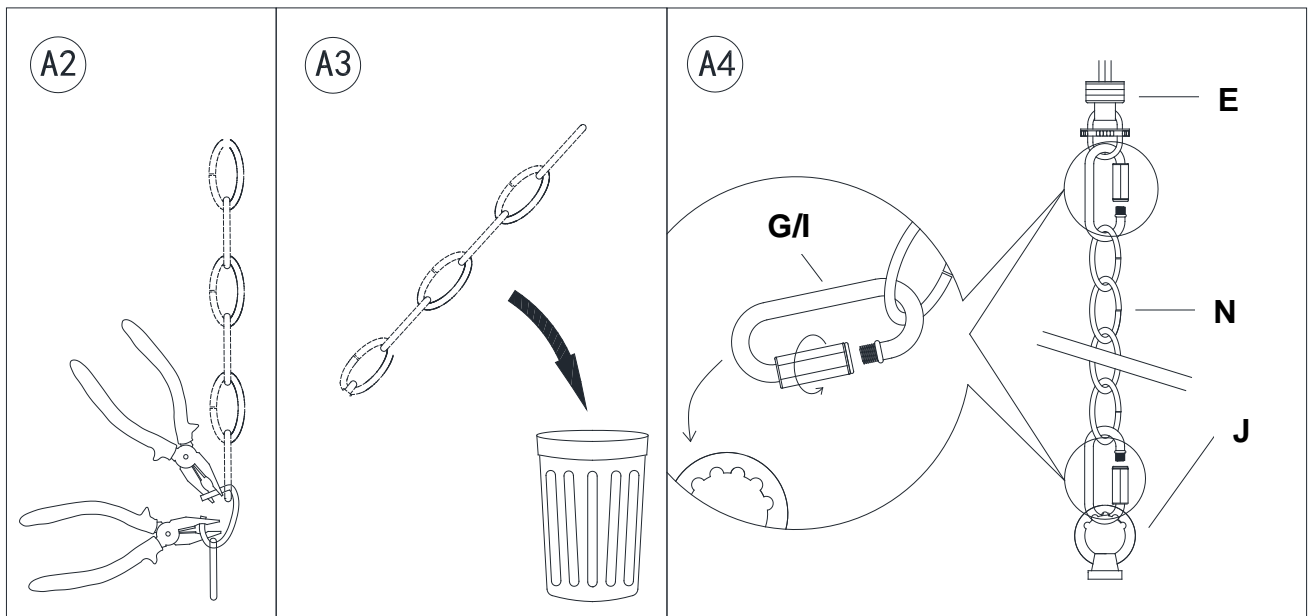

4. (See A5) Re-weave the fixtures 2 wire power cord and bare ground wire through every other loop to the top of Chain (N).

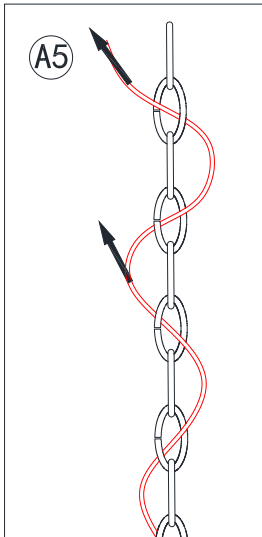

5. (See A6) If needed, cut off the extra power cord length on the fixture 2 wire power cord and bare ground wire so that they all are at least 6 inches (152.4 mm) long within the outlet junction box (J-box).

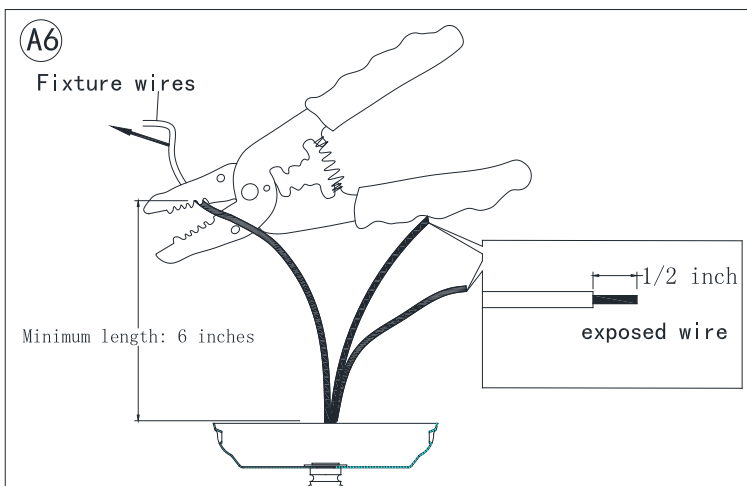

Assembly & Installation Instructions:

- **SHUT OFF THE MAIN ELECTRICAL SUPPLY FROM THE MAIN FUSE BOX/CIRCUIT BREAKER.**
- Carefully unpack all fixture parts and hardware and lay them on a clear workspace.

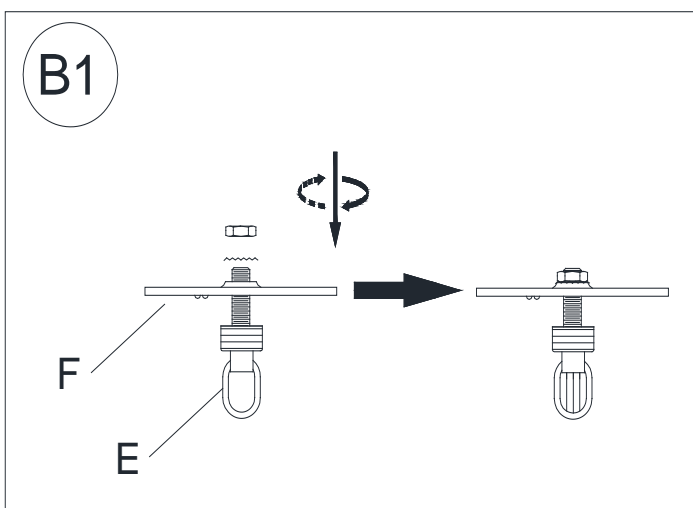

If the parts are not already pre-assembled:

Position a hex nut onto the threaded tube first. Attach the Mounting Plate (F) onto the middle portion of the threaded tube of Hanging Loop (E). Position the lock washer first and use another hex nut to secure the Mounting Plate (F) in place. Tighten the hex nuts using pliers.

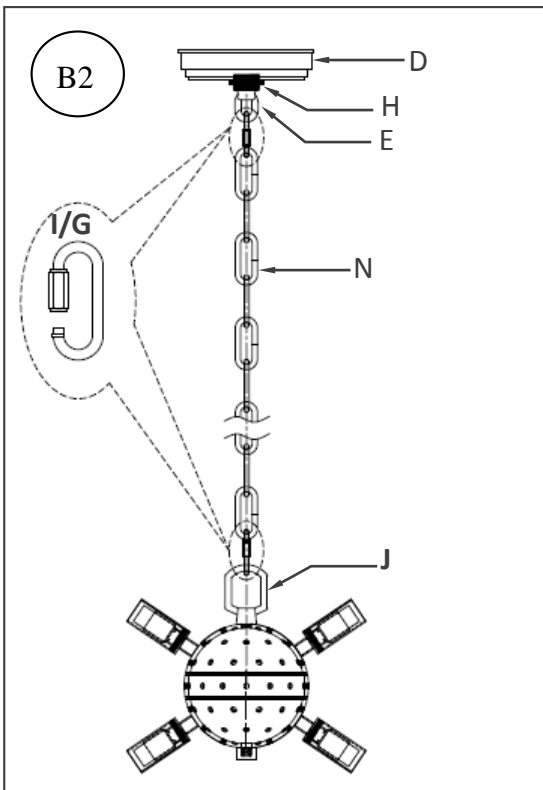

1. Insert the bottom loop of Chain (N) and Fixture Loop (J) into the lower Closable Link (I), tighten the Closable Link Screw Cap.
2. Slide the Canopy Nut (H) over the upper end of Chain (N).
3. Slide the Canopy (D) over the upper end of Chain (N).
4. Insert the top loop of Chain (N) and Hanging Loop (E) into the upper Closable Link (G), tighten the Closable Link Screw Cap.

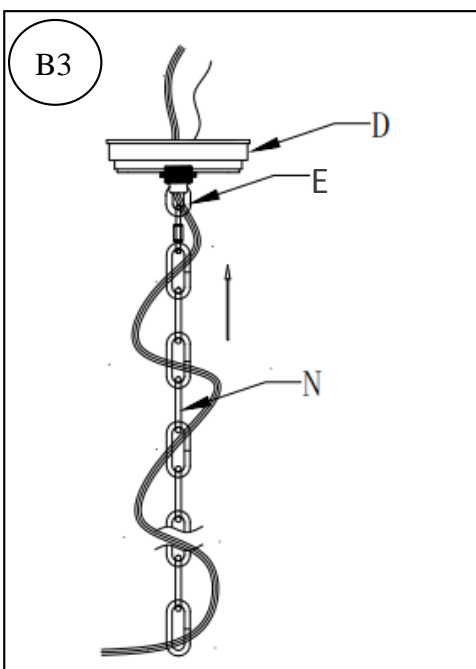

Weave the fixtures 2 wire power cord and bare ground wire through every other loop to the top of Chain (N), and then through the Hanging Loop (E) and Canopy (D).

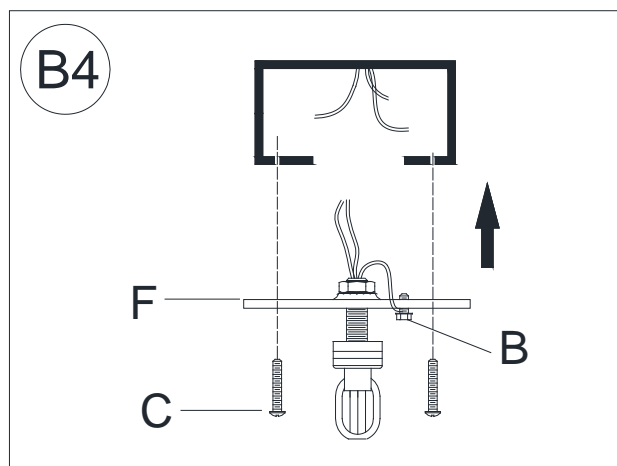

With the help of another person to hold the weight of lighting fixture, attach the Mounting Plate (F) onto the junction box using two Mounting Screws (C). Tighten each screw clockwise with a screwdriver.

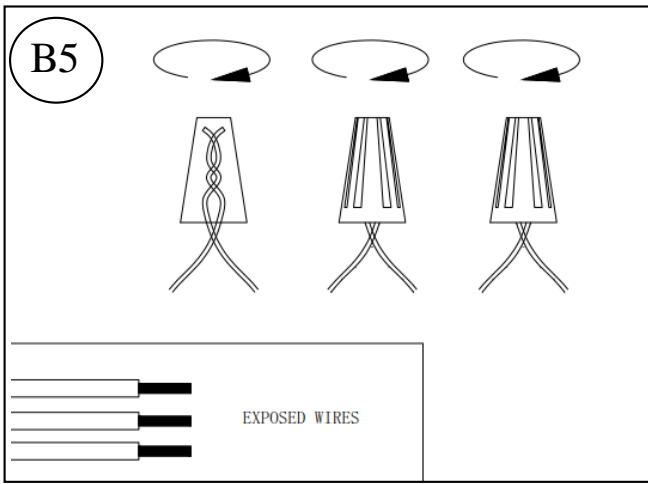

Please read the section **“To Make the Wire Connections”** below.

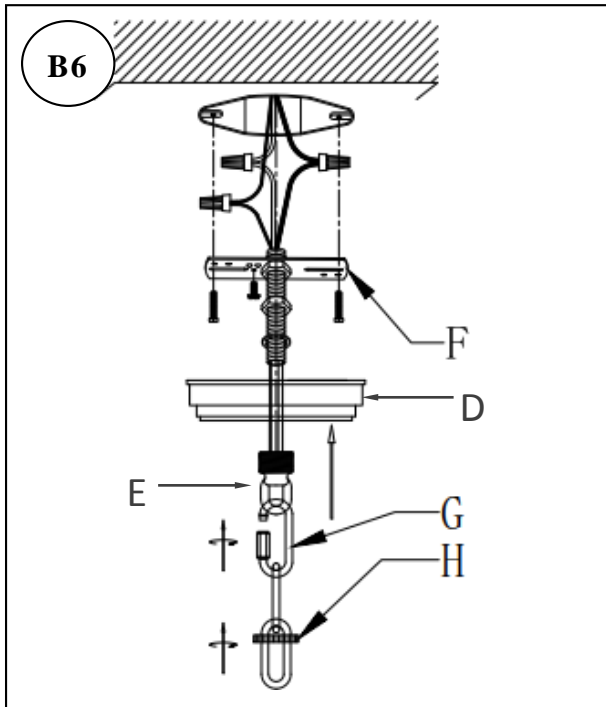

Slide the Canopy (D) upward along the chain until the upper rim of the canopy pressed gently against the ceiling surface. Position the Canopy Nut (H) against the Hanging Loop (E) and rotate the nut clockwise to engage it with the threaded portion of the Hanging Loop (E) until secure. Do not over tighten this nut.

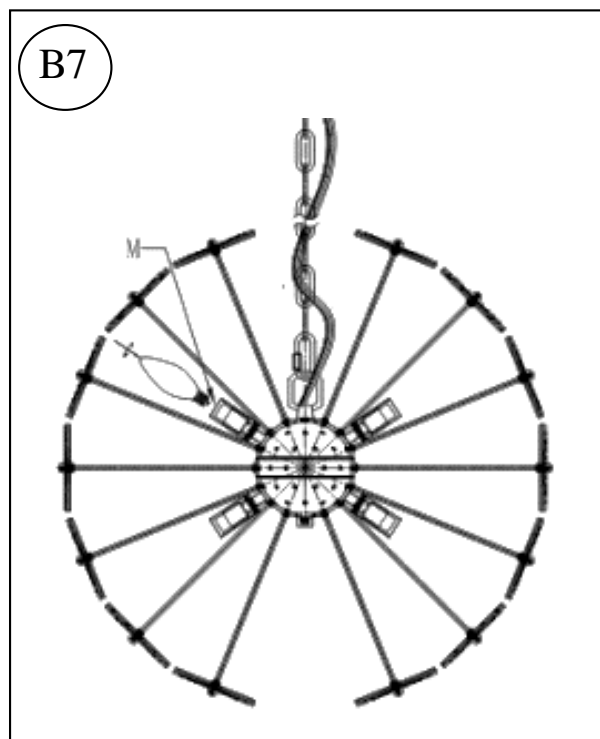

Insert the specified light bulbs into the Sockets (M).
DO NOT EXCEED THE SPECIFIED WATTAGE.

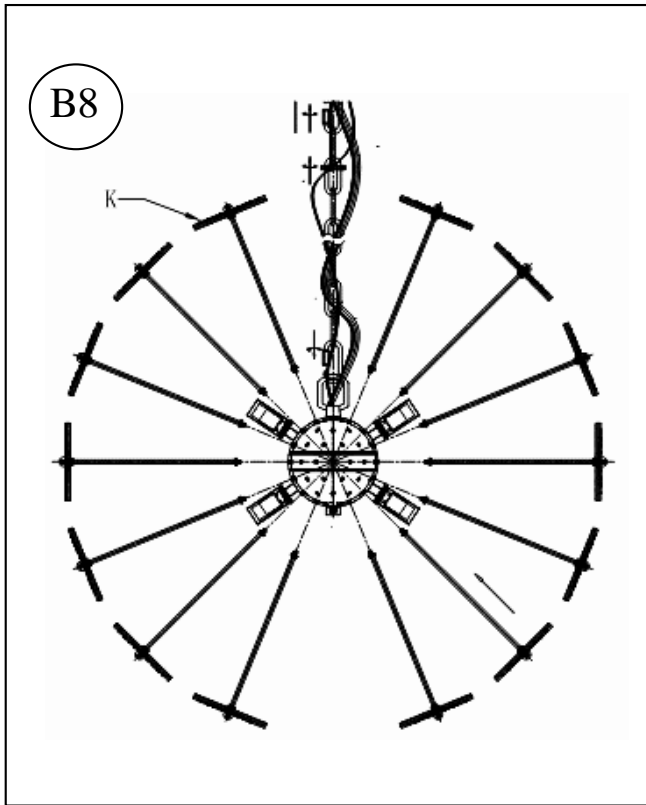

Insert the Metal Rods with Glass Dish (K) into the threaded holes that located around the fixture ball. Rotate each Metal Rods with Glass Dish (K) clockwise until tight.

To Make the Wire Connections:

1. Gently pull existing wire down from the ceiling junction box and allow wires to hang. The HOT or LIVE wire is usually black. The NEUTRAL wire is usually white. Check to see if there is a ground wire that is usually green or green with a yellow stripe or exposed copper metal wire. If needed, use a pair of wire strippers to remove about 1/2 inch of insulation from each wire.
2. Carefully inspect the fixtures wires. The NEUTRAL FIXTURE WIRE has FINE LONGITUDINAL RIDGES running along its length. The HOT FIXTURE WIRE is SMOOTH and the BARE COPPER WIRE is the GROUND WIRE. If you have any doubt and cannot identify the power-supply wires with confidence, then we recommend that you ask an electrician and that you not continue with the installation.
3. With the help of another person to hold the weight of the fixture, attach the fixture wires to the junction box wires as shown in the illustrations.

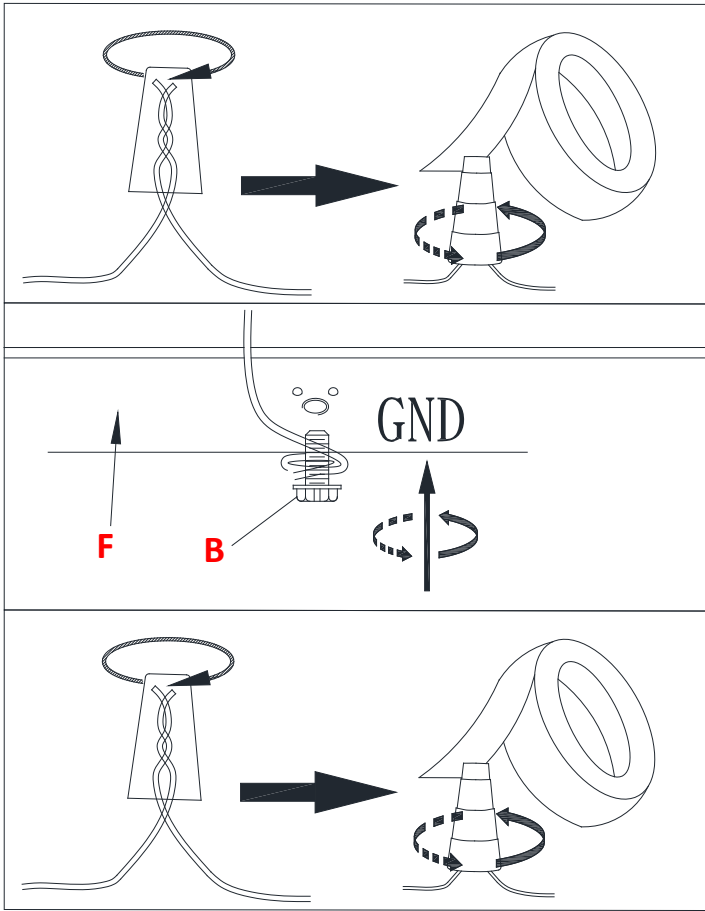

Connect the GROUND FIXTURE WIRE to the GROUND J-BOX WIRE using the Plastic Wire Nut Connector (A) and wrap the connection with electrical tape. Be sure that no wire strands are exposed.

If the junction box DOES NOT have a GROUND WIRE, wrap the fixture's bare ground wire around the Green Ground Screw (B) and insert the screw into the Mounting Plate (F), marked as "GND", and tighten screw to secure the wire.

Connect the NEUTRAL FIXTURE WIRE to the NEUTRAL J-BOX WIRE first and then connect the HOT FIXTURE WIRE to the HOT J-BOX WIRE using the Plastic Wire Nut Connectors (A). Wrap these connections with electrical tape. Be sure that no wire strands are exposed.

NOTE:

**IT IS IMPERATIVE THAT THE JUNCTION BOX IN YOUR HOME BE PROPERLY GROUNDED!
DO NOT REVERSE THE HOT AND NEUTRAL CONNECTIONS OR SAFETY WILL BE COMPROMISED.**

4. Check the wiring connections and if all looks good, gently tuck the wire connections neatly into the ceiling junction box.

Care Instructions:

- Wipe clean with a soft, dry cloth or static duster.
- Always avoid the use of harsh chemicals or abrasive cleaners as they may cause damage to the fixture's finishing.

Thank you for your purchase
Stores | catalog | www.williams-sonoma.com
USA 1.877.812.6235