



## Lamont Linear Crystal Chandelier 48in Assembly and Installation Instructions

### CAUTION:

- **BEFORE INSTALLING FIXTURE, MAKE SURE THE POWER TO THE CIRCUIT IS TURNED OFF AT THE MAIN FUSE BOX / CIRCUIT BREAKER UTILITY BOX.**

### Important Safety Instructions:

- These instructions are provided for your safety. It is very important that they are read carefully and completely before beginning the assembly and installation of this lighting fixture.
- The installation is not to be made on a radiant-heating ceiling.
- The ceiling Toggle-Wings (R) and Toggle Bolts (I) are meant for drywall ceiling mounting only. If the ceiling is made from concrete, brick or plaster, please consult your local hardware store for assistance. Use proper hardware for your ceiling type.
- Due to the large size of the Lamont Crystal Chandelier, the fixture must be attached to the ceiling by the use of the 6 Toggle Bolts (I) (or other additional suitable ceiling mounting hardware, not included) which supports the Mounting Plate (A) along with the two number 10-24 J-box Mounting Screws (O).
- **We strongly recommend that a professional electrician install this lighting fixture.**
- THIS PRODUCT MUST BE INSTALLED IN ACCORDANCE WITH THE APPLICABLE INSTALLATION CODES BY A PERSON FAMILIAR WITH THE CONSTRUCTION AND OPERATION OF THE PRODUCT AND THE HAZARDS INVOLVED.
- **The weight of this lighting fixture exceeds 50 pounds and must be installed using an outlet box approved for up to 100 pounds of lighting fixture load.**
- **THIS LUMINAIRE MUST BE MOUNTED OR SUPPORTED INDEPENDENTLY OF AN OUTLET BOX.**
- The lighting fixture is meant for indoor use. It must be connected only to 3-wire, single-phase electrical supply systems (provided with Ground wire or equivalent protection system).
- For your safety, it is strongly recommended that two people install the lighting fixture.
- This fixture has been rated for up to five (5) **60-watt maximum TYPE B standard (candelabra) incandescent light bulbs** (not included) or five (5) **13-watt compact fluorescent light bulbs** (not included). To avoid the risk of fire, do not exceed the recommended lamp wattage.
- The lighting fixture is meant for indoor use, DRY LOCATIONS ONLY.
- **Save these instructions.**

### WARNING:

- **To reduce the risk of fire, electrical shock or personal injury, always turn off light fixture and allow it to cool prior to replacing light bulb.**
- **Do not touch bulb when fixture is turned on. Do not look directly at lit bulb.**
- **Keep flammable materials away from lit bulb.**
- **This lighting fixture contains lead, a chemical known to the State of California to cause cancer, birth defects and other reproductive harm. Wash hands after installing, handling, cleaning or otherwise touching this light fixture.**

## Pre-assembly:

- Remove all parts and hardware from box along with any plastic protective packaging.
- Do not discard any contents until after assembly is complete to avoid accidentally discarding small parts or hardware.
- For your safety and convenience, assembly by two people is recommended.

## TOOLS REQUIRED (not included):

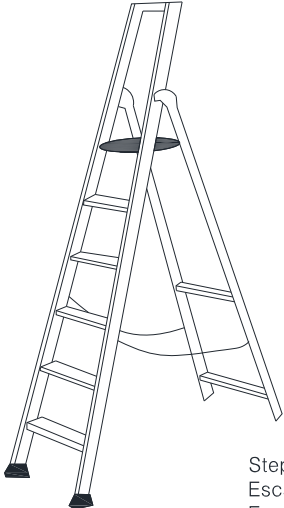
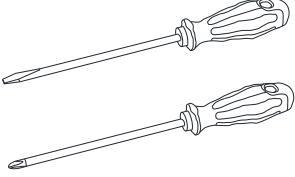
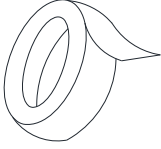
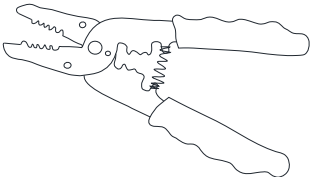
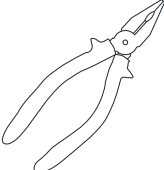
 <p>Step Ladder Escabeau Escalera</p>	 <p>Phillips Head, Flat Blade Screwdrivers Tournevis à tête Phillips et à tête plate Destornilladores Cabeza Phillips y Destornilladores Cabeza Plana</p>	 <p>Electrical tape Ruban isolant Cinta Electrica.</p>
	 <p>Wire Cutter/Stripper Pince coupe-fil/ à dénudé Cortador de Cable</p>	 <p>Plier Pince Alicates</p>

## Parts Included:

- (A) Mounting Plate (1)
- (B) Mounting Loop (1)
- (C) Canopy (1)
- (D) Big Closable Links with Screws Caps (2)
- (E) Canopy Nuts (2)
- (F) Chain (1)
- (G) Hanging Loop (2)
- (H) Sockets (5)

## Hardware Enclosed:

- (I) Toggle Bolts with Flat Washers (6)
- (J) Small Flat Washers (8)
- (K) Toggle Nuts (6)
- (L) Small Closable Links with Screws Caps (4)
- (M) Plastic Wire Nut Connectors (3)
- (N) Green Ground Screw (1)
- (O) Mounting Screws (2)
- (P) Nuts (2)
- (Q) Washers (2)
- (R) Toggle Wings (6)

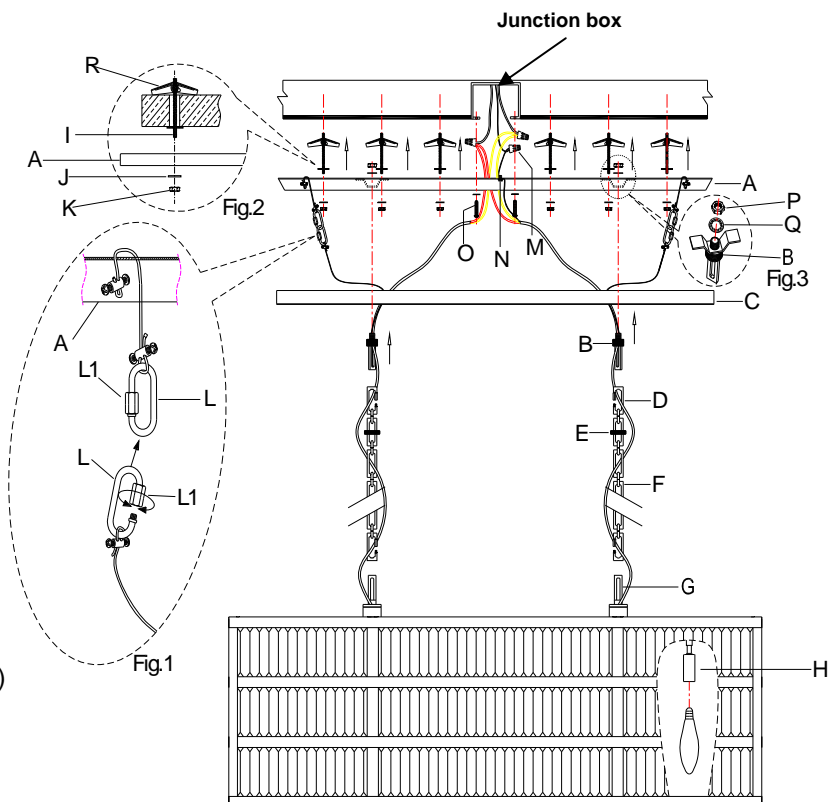

## To adjust the suspension length of the fixture:

1. Note: The adjustment or shortening of the lighting fixture's suspension length is only needed if the factory set chain length is not appropriate for your installation. We recommend that you adjust the chain to the proper desired length before cutting the electrical cord. Determine the lighting fixture suspension length from the ceiling for the product installation, allowing the extra cord length for the outlet junction box wire connections as noted below.
2. (See A1 & A2) There are different hanging lengths for this light fixture as below:
  - a. Unscrew the closable links (D) by loosen the screw caps, attach one of closable link (D) to Hang Loop (G) and one of closable link (D) to Mounting Loop (B) and secure with screw caps.(See A1)
  - b. To shorten the Chain (F) by using bolt cutters to the chain at the desired length. Attach both Closable Links (D) to both ends of the Chain (F) and secure with Screw caps (See A2).

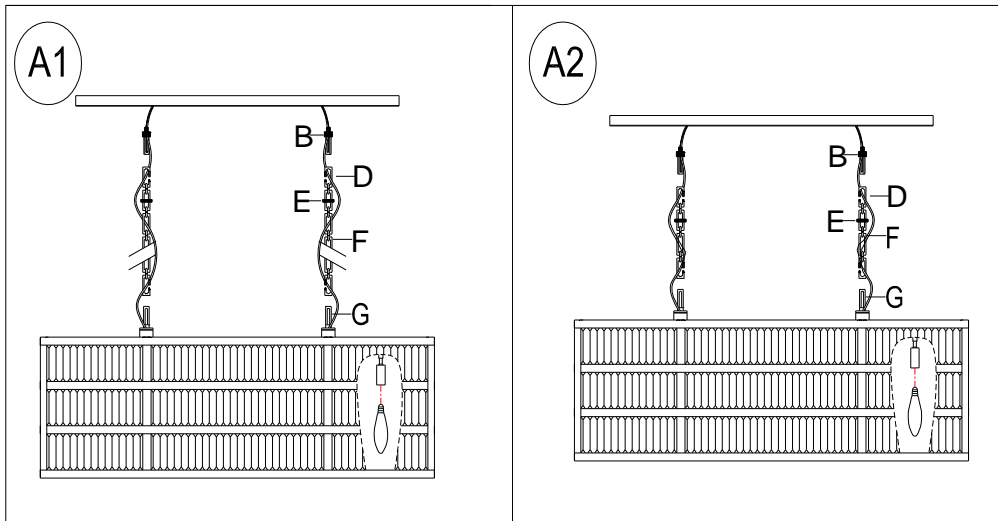

## Before Assembly: (To change the broken crystal)

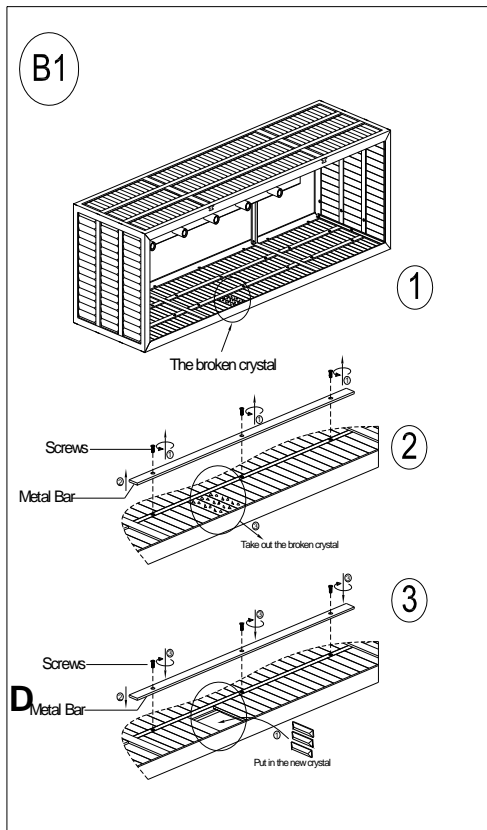

1. Carefully place the light fixture on a work place to check the crystal.
2. If there are some broken crystals, extra crystal parts are included in box.
3. Unscrew the screws by turning in a counter-clockwise direction, take away the Metal Bar and take out the broken crystal. Do not discard the Metal Bar as well it will be used later.
4. Install the new crystal one by one, then replace the Metal Bar to the light fixture and secure with Screws.

## Assembly & Installation Instructions:

1. **SHUT OFF THE MAIN ELECTRICAL SUPPLY FROM THE MAIN FUSE BOX/CIRCUIT BREAKER!**
2. Carefully unpack all fixture parts and hardware and lay them out on a clear workspace.
3. If the parts are not already preassembled or if suspension length adjustments were not made, please use the instruction section above "To Adjust the Suspension Length of the Fixture" for the proper assembly to the desired suspension length.
4. If needed, separate the Mounting Plate (A) from the Canopy (C) by unscrewing the Canopy Nuts.
5. Unscrew the Big Closable Link (D), attach one of the Closable Link (D) to Mounting Loop, one of the Closable Link (D) to the Hanging Loop (G) and secure with screws caps.
6. Slide the Canopy Nuts (E) and Canopy (C) on Chain (F).
7. Determine the desired location of the lighting fixture and temporarily install the Mounting Plate (A) to the ceiling J-box. Attach the Mounting Plate (A) to the ceiling outlet box using the two number 10-24 J-box Mounting Screws (O) and 2 Small Flat Washers (J) Align the slots of the Mounting Plate (A) with the two number 10-24 threaded holes located on the J-Box. Use a screwdriver to tighten each screw until the Mounting Plate (A) is firmly secured to the J-Box.
8. Mark the 6 slot locations of the Mounting Plate (A) on the ceiling using a pencil where holes will be drilled for the 6 Toggle Bolts (I) and Toggle Wings (R)
9. Un-install the Mounting Plate (A) from the marked ceiling outlet box location by loosening and removing the 2 Mounting Screws (O) and 2 Small Flat Washers (J) with a screwdriver.
10. Attach Mounting Loops (B) to the bracket on Mounting Plate (A), letting the nipples on Mounting Plate (B) pass through the holes of the bracket on Mounting Plate (A) and secure with Washers (Q) and Nuts (P). Tighten with a screwdriver. (See Fig.3)
11. Using the drill with the appropriate size drill bit (just large enough to make hole that will allow passage of the folded Toggle Wings (R) of each Bolt (I), drill 1 hole in the ceiling at each of the 6 marked slot locations for the Toggle Wing (R) and Toggle Bolt (I) assemblies.
12. Use the **assembled** Toggle Bolts and Toggle Wings (I & R), inserted through each of the 6 ceiling holes, making sure only the Toggle Wings (R) are fully inserted into the ceiling and the toggle wings are open as shown in the Fig.2 . Rotate each installed Toggle Bolt (I) in a clockwise direction until each flat washer on the Toggle Bolt (I) is tight against the ceiling. **NOTE: The Toggle Bolts with Flat Washers (I) must be securely fastened to the ceiling. Then the Mounting Plate (A) installed up against the ceiling, first secured by the two number 10-24 J-box Mounting Screws (O) and 2 Small Flat Washers (J), and finally the 6 Toggle Nuts (K) with remaining Small Flat Washers (J), against the Mounting Plate (A)! The threaded rods must not spin in place when the Toggle Nuts (K) are tightened!**
13. Gently pull the existing wire down from the ceiling junction box and allow wires to hang through the center opening of Mounting Plate (A). The HOT or LIVE wire is usually black. The NEUTRAL wire is usually white. Check to see if there is a ground wire that is usually green or green with a yellow stripe or exposed copper metal wire. If needed, use a pair of wire strippers to remove about 1/2 inch of insulation from each wire.
14. **The weight of this lighting fixture exceeds 50 pounds and must be installed using an outlet box approved for up to 100 pounds of lighting fixture load. THIS LUMINAIRE MUST BE MOUNTED OR SUPPORTED INDEPENDENTLY OF AN OUTLET BOX.**
15. Attach the Mounting Plate (A) to the ceiling outlet box using the two number 10-24 J-box Mounting Screws (O) and 2 Small Flat Washers (J) Align the slots of the Mounting Plate (A) with the two number 10-24 threaded holes located on the J-Box. Use a screwdriver to tighten each screw, turning clockwise until the Mounting Plate (A) is firmly secured to the J-Box. (See diagram)

16. Position the Small Flat Washers (J) first and then Toggle Nuts (K) onto the exposed threaded portion of each Toggle Bolt (I), against the Mounting Plate (A), then tighten each nut, turning clockwise until tight. (See Fig. 2).
17. If needed, (depending upon final fixture hanging position from the ceiling), cut off the extra power cord length on the 3 wire cord. Make sure when cutting the power cord to the cord so that it is at least 6 inches (152.4 mm) long within the outlet junction box (J-box). Prepare the cut power cord wires using the following steps. Carefully cut away about 3 inches of the outer protective insulation of the three-wire cord cable to expose the three individually sheathed wires. Use wire strippers to prepare the ends of the three wires so that there is about 1/2 inch of exposed wire for the Plastic Wire Nut Connectors (M).
18. With the help of another person to hold the weight of the lighting fixture, unscrew the Closable Link Screw Cap (L1) from the Closable Link (L), attach each Closable Link (L) from the Mounting Plates (A) onto each Closable Link (L) from the Canopy (C). Tighten each Closable Link Screw Cap (T1) as shown in Fig. 1. Now the lighting fixture is supported by the steel wires.
19. Carefully inspect the fixtures wires. The NEUTRAL FIXTURE WIRE has FINE LONGITUDINAL RIDGES running along its length. The HOT FIXTURE WIRE is SMOOTH and the bare copper wire is the GROUND WIRE. If you have any doubt and cannot identify the power-supply wires with confidence, then we recommend that you ask an electrician and that you not continue with the installation.
20. Gently pull existing wire down from the ceiling junction box and allow wires to hang. The HOT or LIVE wire is usually black. The NEUTRAL wire is usually white. Check to see if there is a ground wire that is usually green or green with a yellow stripe or exposed copper metal wire. If needed, use a pair of wire strippers to remove about 1/2 inch of insulation from each wire.
21. Attach the GROUND WIRE from the fixture to the GROUND JUNCTION BOX WIRE from the ceiling outlet junction box (J-box) (usually green insulation or bare wire). Fasten each together with a Plastic Wire Nut Connector (A) by twisting the connector in a clockwise direction and wrap the connection with electrical tape. Be sure that no wire strands are exposed. If your outlet junction box DOES NOT have a GROUND WIRE, be sure to insert the Green Ground Screw (N) into the Mounting Plate (A), marked as "GND", facing downward and wrap the fixture's bare ground wire around the Green Ground Screw (N). Tighten screw to clamp ground wire between ground screw head and Mounting Plate (A). **IT IS IMPERATIVE THAT THE JUNCTION BOX IN YOUR HOME BE PROPERLY GROUNDED!**
22. Connect the NEUTRAL FIXTURE WIRE to the NEUTRAL JUNCTION BOX WIRE (usually white insulation). Fasten each together with a Plastic Wire Nut Connector (M) by twisting the connector in a clockwise direction and wrap the connection with electrical tape. Be sure that no wire strands are exposed.
23. Connect the HOT FIXTURE WIRE to the HOT JUNCTION BOX WIRE (usually black insulation). Fasten each together with a Plastic Wire Nut Connector (M) by twisting the connector in a clockwise direction and wrap the connection with electrical tape. Be sure that no wire strands are exposed. **DO NOT REVERSE THE HOT AND NEUTRAL CONNECTIONS OR SAFETY WILL BE COMPROMISED.**
24. Check the wiring connections and if all looks good, gently tuck the wire connections neatly into the ceiling junction box.
25. Slip the Canopy (C) to the affixed Mounting Plate (A) and position the Canopy Nuts (E) against the Mounting Loop (B) and rotate the Canopy Nuts (E) clockwise to engage it with the threaded portion of the Mounting Loop (B) until secure.
26. Insert five (5) **60-watt maximum TYPE B standard (candelabra) incandescent light bulbs** (not included) or five (5) **13-watt compact fluorescent light bulbs** (not included) into Sockets (H). **DO NOT EXCEED THE SPECIFIED WATTAGE.**
27. Assembly and installation is complete. Restore power to ceiling outlet junction box and test fixture.

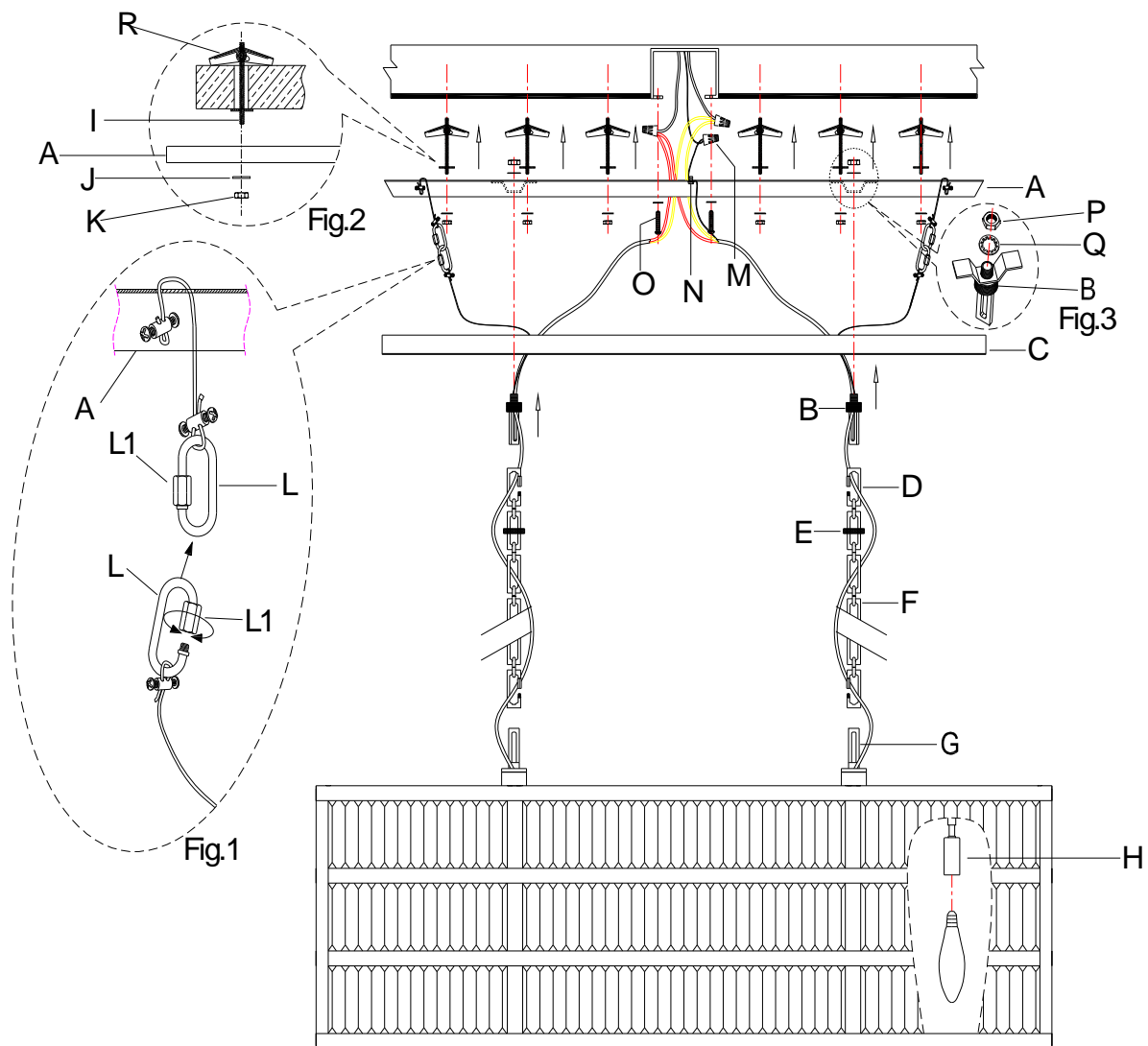

**Care instructions:**

- Wipe clean with a soft, dry cloth or static duster.
- Always avoid the use of harsh chemicals or abrasive cleaners as they may cause damage to the fixture's finish.

Thank you for your purchase  
 Stores | catalog | [www.williams-sonoma.com](http://www.williams-sonoma.com)  
 USA 1.877.812.6235