

# Cuisinart®

INSTRUCTION  
BOOKLET



**Electric Knife**

**CEK-40**

---

## IMPORTANT SAFEGUARDS

When using an electrical appliance, basic safety precautions should always be followed:

1. **READ ALL INSTRUCTIONS.**
2. **Unplug from outlet when not in use, before putting on or taking off parts, and before cleaning.**
3. To protect against risk of electrical shock, do not put the knife handle in water or other liquid. If handle or cord falls into liquid, unplug the cord from outlet immediately. Do not reach into the liquid.
4. To avoid possible accidental injury, close supervision is necessary when any appliance is used by or near children.
5. Avoid contact with moving parts. Keep hands, hair, clothing and other utensils away from blade during operation to reduce risk of injury to persons and/or damage to the knife.
6. Do not operate any appliance with a damaged cord or plug or after the appliance has malfunctioned or has been dropped or damaged in any way or is not operating properly. Return the appliance to the nearest Cuisinart Repair Center for examination, repair, mechanical or electrical adjustment.
7. The use of attachments not recommended by Cuisinart may cause fire, electrical shock, or risk of injury.

8. Do not use outdoors or anywhere the cord or knife might come into contact with water while in use.
9. To avoid the possibility of the knife being accidentally pulled off work area, which could result in damage to the knife or personal injury, do not let cord hang over edge of table or counter.
10. To avoid damage to cord and possible fire or electrocution hazard, do not let cord contact hot surfaces, including a stove.
11. Do not operate knife in water or under running water.
12. Unplug cord from outlet when inserting, removing or changing blades.
13. Blades are sharp. Handle carefully. Always handle blades with hand away from cutting edge. Always store blades with cutting edge away from you.
14. Do not operate your appliance in an appliance garage or under a wall cabinet. **When storing in an appliance garage always unplug the unit from the electrical outlet.** Not doing so could create a risk of fire, especially if the appliance touches the walls of the garage or the door touches the unit as it closes.

## SAVE THESE INSTRUCTIONS FOR HOUSEHOLD USE ONLY

### NOTICE:

This appliance has a polarized plug (one prong is wider than the other). As a safety feature, this plug will fit into a polarized outlet only one way. If the plug does not fit fully in the outlet, reverse the plug. If it still does not fit, contact a qualified electrician. Do not attempt to defeat this safety feature.

## UNPACKING INSTRUCTIONS

### IMPORTANT PLEASE READ

This package contains a Cuisinart® Electric Knife with the following parts:

- Knife Handle
- Carving Blade
- Bread Blade
- Butcher Block Wood Stand and
- Instruction Booklet

To avoid any injury to yourself or damage to the Cuisinart® Electric Knife, please follow these unpacking instructions:

1. Place the gift box containing your Cuisinart® Electric Knife on a flat, sturdy surface before unpacking.
2. Remove the Instruction Booklet and other printed materials.
3. Next, turn the box on its side and slide the entire unit out including packing materials.
4. Carefully remove the foam plastic blocks from each side of the unit.

5. Lift unit off the corrugated tray.
6. Place the unit on a counter or table and read the instructions thoroughly before using.
7. Save shipping carton and inserts for later use.

**NOTE:** Remember to return your warranty card with all information carefully and completely filled out.

## CONTENTS

Features & Benefits . . . . .	3
Use & Care . . . . .	4
Cleaning, Storage and Maintenance. . . . .	4
Helpful Hints . . . . .	5
How To Carve a Turkey . . . . .	5
Best Methods of Slicing Bread. . . . .	6
How To Carve Ham on the Bone . . . . .	6
Warranty . . . . .	7

## FEATURES AND BENEFITS

- 1. On/Off Control:**  
One touch pressure activated on/off trigger control for simple operation. Convenient for left or right hand use.
- 2. Handle:**  
Elegant ergonomic handle reflects look and feel of fine cutlery.
- 3. Electrical cord:**  
4 foot cord for maximum flexibility.
- 4. Safety Button:**  
One touch locks or unlocks the on/off control for safety. Keep the safety button locked when knife is not in use.
- 5. Blade Release Buttons:**  
Easy inserting, removing or changing blades.
- 6. Blades:**  
Two full size blades. (A) Carving Blade and (B) Bread blade.
- 7. Solid Wood Butcher Block:**  
Premium unit crafted from hardwood. For easy, attractive storage on countertop or in drawer.
- 8. Blade Lock:**  
Safely locks blades to wood block.
- 9. Cord Storage:**  
Eliminates countertop clutter.
- 10. Base:** For countertop storage.
- 11. BPA-Free (not shown):**  
All materials that come in contact with food are BPA-Free.

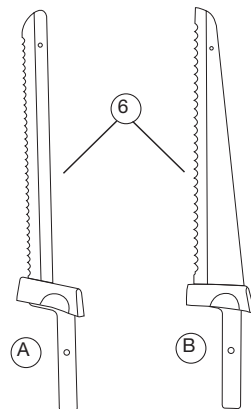
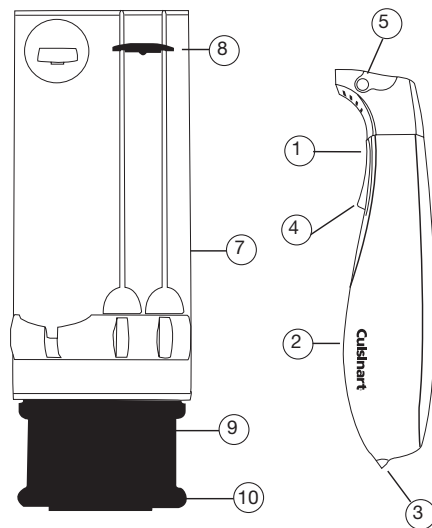

## USE AND CARE

### Assembling the Butcher Block:

1. Push base toward the underside of butcher block and insert the tab on the bottom of the base into the slot on the edge of the block.
2. Stand unit on counter for easy access.
3. Reverse steps 1 and 2 for in-cabinet storage.

Note: Do not use Butcher Block as a cutting board.

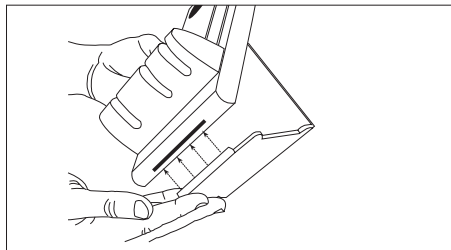

### Assembling the Blades:

1. Lift and turn blade lock to a vertical position to remove blades from base. Remove protective sleeves. Before first use, separate the blades and wash them in hot, soapy water or the dishwasher. **CAUTION: BLADES ARE SHARP. HANDLE WITH CARE.** Dry thoroughly.

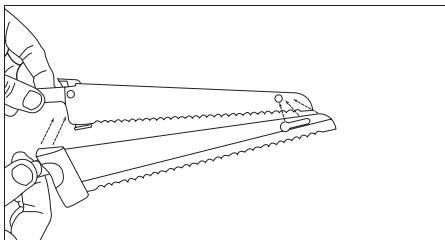
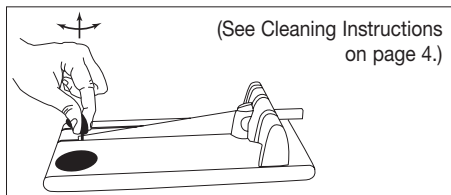

2. Attach the blades by inserting the rivet on one blade into the keyhole of the other blade.

### Using your Cuisinart® Electric Knife:

1. The knife should be unplugged when fitting the blades. The blades must be assembled before fitting into knife. The safety button should be in the locked position. Achieve this by pushing the small tab on the side of the trigger button. (While looking at the underside of handle, push the tab on the left side to unlock.)

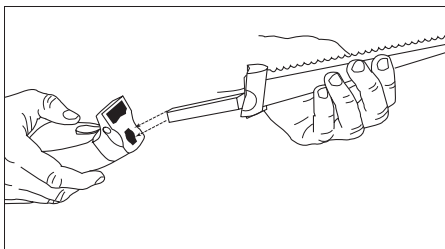

While holding the blades with the serrated edge away from you, insert blades until you hear a "click". The blades may not line up evenly when properly inserted.

**Caution:** The blades are very sharp; be careful when handling them.

2. Plug the cord into a standard electrical outlet.

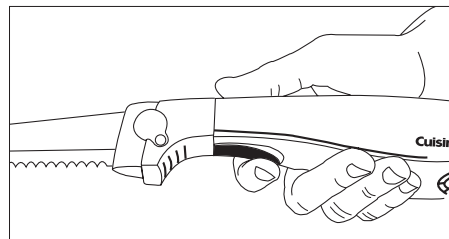

3. Unlock the safety button.
4. Squeeze and hold the trigger button with your fingers as you cut. Blades should stay parallel to the cutting surface.

**Caution:** NEVER place your hand on top of the blade to support it while operating the knife as the blades are designed to move back and forth.

5. Blade automatically stops when trigger is released.

## CLEANING, STORAGE AND MAINTENANCE

1. To remove the blades, unplug the knife. Lock the safety button. Squeeze the Blade Release Buttons on both sides of the handle and grasp the blades with the cutting edge away from you. Slowly pull blades out from knife handle.
2. To wash, separate the blades by sliding the rivet out of the keyhole. Wash them in hot, soapy water or the dishwasher and dry

thoroughly. Return to butcher block tray. Lift and turn blade lock positioning over blades and release to lock blades into position.

3. Clean the handle with a slightly damp cloth and wipe dry. Insert in butcher block and hook into slits on head of handle. Wrap cord around black base area.

**Caution:** Do not clean handle with blades in place. Do not immerse the appliance in water or other liquid or place it under running water.

**Maintenance:** Any other servicing should be performed by an authorized service representative.

## HELPFUL HINTS

Carving Blade:

The carving blade is very versatile. In addition to slicing meats such as turkey, chicken, salami, ham and roasts, it can also be used to cut fruits like melon and pineapple, vegetables such as squash, eggplant and zucchini, as well as hard cheeses.

Bread Blade:

The bread blade glides through loaves for consistent, even slicing. It can also be used to slice bagels and sandwich rolls.

## HOW TO CARVE A TURKEY

Carving a large bird, especially in front of hungry guests, can be a daunting task— the watering mouths, critical eyes, rumbling stomachs. With the Cuisinart® Electric Knife, a little guidance and some helpful hints...we hope to make this task a pleasurable experience.

**Tip:** Cut dark meat first, as it does not dry out as quickly as the white meat of the breast.

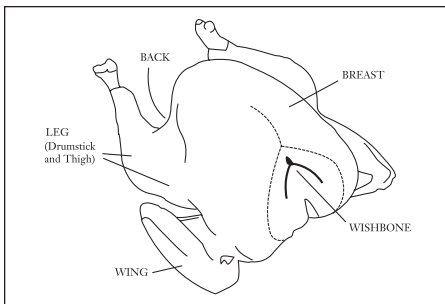

### Preparation:

1. Remove the turkey from the oven.
2. Cover loosely with foil and let stand 15-30 minutes to let the juices set and the meat firm up. The turkey will be more moist, easier to carve, and the slices will hold together better.
3. Remove the stuffing.
4. Place turkey on a carving board, breast side up, with the legs facing you. You'll need your Cuisinart® Electric Knife and a large carving fork to hold the bird.

### Cutting the legs and wings:

1. Hold the tip of one drumstick with your fingers and gently pull the leg away from the body of the turkey.
2. Holding the turkey steady with a carving fork, cut the skin between the thigh and the breast.
3. Pull the leg out further to expose the joint where the thigh connects and cut through joint with the knife to remove the leg.

4. Next, hold the drumstick with the fork and cut at the joint between the drumstick and thigh to separate the two pieces.
5. Slice the meat on the drumstick by cutting along the bone to get thick slices.
6. Turn the drumstick and continue slicing along the bone until all of the meat is removed.
7. To remove meat from the thigh, cut thick slices to the bone. If the turkey is small, the drumstick and thigh may be served whole.
8. Using the fork, hold the wing away from the body and cut through the joint. The wing can be served as is.
9. Repeat on other side to remove leg and wing.

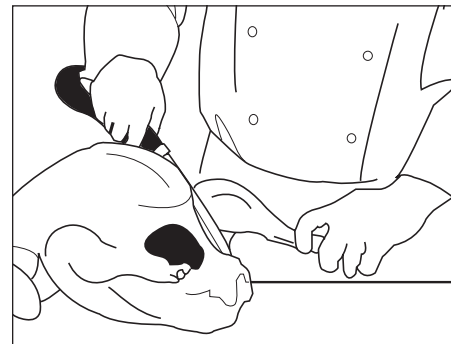

**Tip:** The key to carving the thighs, legs, and wings is to cut through the joints, and not through the bones. **We do not recommend using your Cuisinart® Electric Knife on bones as it could cause damage to the knife or personal injury.**

### Carving the breast:

1. Hold the breast with the carving fork, and starting at the outer side of one breast, cut slices parallel to the ribcage, from the top of the breast downward. The slices should be thin, even and the entire length of the breast. The slices will get larger as you work toward the ribcage. Continue slicing until you reach the bones.

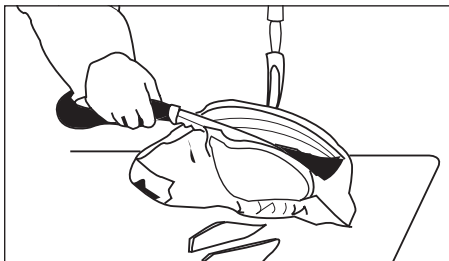

2. Repeat on the other side of the breast.

**Tip:** Angle the knife parallel to the ribcage, rather than digging into the meat.

**Tip:** Some yummy leftovers that can be made from the smaller pieces of meat near the bones include: soup, casserole, chili, salad, tacos, etc.

## BEST METHODS OF SLICING BREAD

### How to cut bread:

There are several ways to cut bread. Two of the most popular are to cut straight across, or in a herringbone pattern, which works only with rounded loaves of bread.

### Standard slices:

1. First, to cut the bread straight across, place the loaf on a carving board.
2. Holding the bread firmly yet gently in one hand, place the knife over the bread, parallel to the carving board, making sure the tip of the knife extends past the side of loaf.
3. Cut slices to preference.

**Tip:** The Cuisinart® Electric Knife works well on bread by gently pulling the knife towards you as it cuts downward through the bread.

### Herringbone pattern:

Cutting bread in a herringbone pattern is more difficult and produces smaller pieces of bread, although you still control the thickness of the slice.

1. To begin, hold the bread firmly yet gently in one hand and angle the knife across the corner of one of the smaller ends of the loaf, making sure the blade is parallel to the carving board. The slice should start in the middle of the loaf and angle towards the outside, cutting off the rounded crust.
2. The next slice starts again from the center of the loaf but angles toward the other side of the bread, cutting off a larger slice with crust.

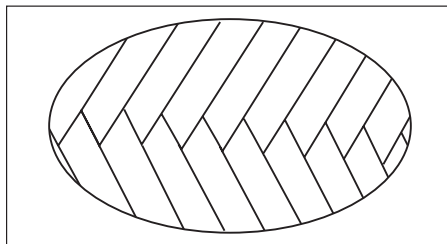

3. Repeat step one, alternating cutting each side at an angle.

**Tip:** To cut in the herringbone pattern, you may need to turn the bread or vary your stance as you switch cutting sides.

## HOW TO CARVE HAM ON THE BONE

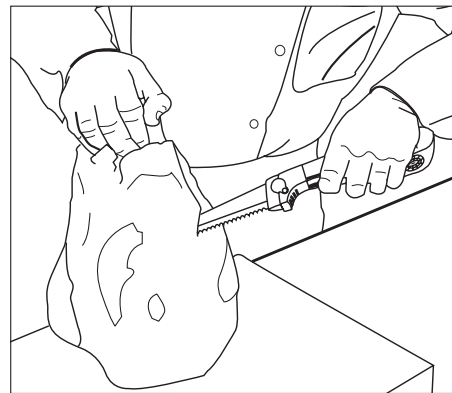

1. Remove the ham from the oven, cover loosely with foil and let stand for 20 minutes.
2. Place ham on a carving board.
3. Holding the ham steady with a carving fork, use your Cuisinart® Electric Knife to trim away the excess fat from the outside of the ham.
4. Next, stand the ham on end, holding the shank (smaller) end in your hand.
5. Slice into the ham just below the shank, at the

stifle joint, where the ham gets bigger.

6. Cut along the bone, which is curved, and then around the socket joint at the sirloin end. The meat will not cut completely away from the bone yet.
7. Rotate the ham so the uncut side is up, and holding the shank end with your hand, slice into the ham at the joint, cutting downward until the meat falls away from bone.
8. Cut off any large remaining pieces of meat. Carve the ham in even slices, keeping your knife parallel to the carving board and holding the ham securely with a carving fork.

## WARRANTY

### Limited Three-Year Warranty

This warranty is available to consumers only. You are a consumer if you own a Cuisinart® Electric Knife that was purchased at retail for personal, family or household use. Except as otherwise required under applicable law, this warranty is not available to retailers or other commercial purchasers or owners. We warrant that your Cuisinart® Electric Knife will be free of defects in materials and workmanship under normal home use for 3 years from the date of original purchase.

We recommend that you visit our website, [www.cuisinart.com](http://www.cuisinart.com) for a fast, efficient way to complete your product registration. However, product registration does not eliminate the need for the consumer to maintain the original proof of purchase in order to obtain the warranty benefits. In the event that you do not have proof of purchase date, the purchase date for purposes of this warranty will be the date of manufacture.

### CALIFORNIA RESIDENTS ONLY

California law provides that for In-Warranty Service, California residents have the option of returning a nonconforming product (A) to the store where it was purchased or (B) to another retail store that sells Cuisinart® products of the same type. The retail store shall then, according to its preference, either repair the product, refer the consumer to an independent repair facility, replace the product, or refund the purchase price less the amount directly attributable to the consumer's prior usage of the product. If neither of the above two options results in the appropriate relief to the consumer, the consumer may then take the product to an independent repair facility, if service or repair can be economically accomplished. Cuisinart and not the consumer will be responsible for the reasonable cost of such service, repair, replacement, or refund for nonconforming products under warranty. California residents may also, according to their preference, return nonconforming products directly to Cuisinart for repair or, if necessary, replacement by calling our Consumer Service Center toll-free at 800-726-0190. Cuisinart will be responsible for the cost of the repair, replacement, and shipping and handling for such nonconforming products under warranty.

### BEFORE RETURNING YOUR CUISINART® PRODUCT

If your Cuisinart® Electric Knife should prove to be defective within the warranty period, we will repair or, if we think necessary, replace it. To obtain warranty service, please call our Customer Service Center toll-free at 1-800-726-0190 or write to: Cuisinart, 7811 North Glen Harbor Blvd. Glendale, AZ 85307. To facilitate the speed and accuracy of your return, enclose

\$10.00 for shipping and handling. (California residents need only supply a proof of purchase and should call 1-800-726-0190 for shipping instructions.) Please be sure to include your return address, description of the product's defect, product serial number, and any other information pertinent to the return. Please pay by check or money order. NOTE: For added protection and secure handling of any Cuisinart® product that is being returned, we recommend you use a traceable, insured delivery service. Cuisinart cannot be held responsible for in-transit damage or for packages that are not delivered to us. Lost and/or damaged products are not covered under warranty.

Your Cuisinart® Electric Knife has been manufactured to the strictest specifications and has been designed for use only in 120 volt outlets and only with authorized accessories and replacement parts. This warranty expressly excludes any defects or damages caused by attempted use of this unit with a converter, as well as use with accessories, replacement parts or repair service other than those authorized by Cuisinart. This warranty does not cover any damage caused by accident, misuse, shipment or other than ordinary household use. This warranty excludes all incidental or consequential damages. Some states do not allow the exclusion or limitation of these damages, so these exclusions may not apply to you. You may also have other rights, which vary from state to state.

**Important:** If the nonconforming product is to be serviced by someone other than Cuisinart's Authorized Service Center, please remind the servicer to call our Consumer Service Center at 1-800-726-0190 to ensure that the problem is properly diagnosed, the product is serviced with the correct parts, and to ensure that the product is still under warranty.

# Cuisinart®

SAVOR THE GOOD LIFE®



Coffeemakers



Blenders



Juicers



Cookware



Tools and  
Gadgets

Cuisinart offers an extensive assortment of top quality products to make life in the kitchen easier than ever. Try some of our other countertop appliances, cookware, tools and gadgets.

**[www.cuisinart.com](http://www.cuisinart.com)**

©2012 Cuisinart  
150 Milford Road  
East Windsor, NJ 08520

Printed in China

Any other trademarks or service marks referred to herein are the trademarks or service marks of their respective owners.

11CE127874

F IB-3700C