



Adriana Globe Pendant Assembly and Installation Instructions

CAUTION:

- **BEFORE INSTALLING FIXTURE, MAKE SURE THE POWER TO THE CIRCUIT IS TURNED OFF AT THE MAIN FUSE BOX / CIRCUIT BREAKER UTILITY BOX.**

Important Safety Instructions:

- These instructions are provided for your safety. It is very important that they are read carefully and completely before beginning the assembly and installation of this lighting fixture.
- We strongly recommend that a professional electrician install all direct wire fixtures.
- THIS PRODUCT MUST BE INSTALLED IN ACCORDANCE WITH THE APPLICABLE INSTALLATION CODES BY A PERSON FAMILIAR WITH THE CONSTRUCTION AND OPERATION OF THE PRODUCT AND THE HAZARDS INVOLVED.
- The lighting fixture is meant for indoor use. It must be connected only to 3-wire, single-phase electrical supply systems (provided with Ground wire or equivalent protection system).
- For your safety, it is strongly recommended that two people install the lighting fixture.
- This fixture has been rated for up to E26 one (1) **60-Watt maximum TYPE A standard (candelabra) incandescent light bulb** (not included) or one (1) **13-Watt compact fluorescent light bulb** (not included) or one (1) **9-watt SBLED light bulb** (not included). To avoid the risk of fire, do not exceed the recommended lamp wattage.
- This lighting fixture is intended for indoor or protected/covered outdoor areas. Do not expose to direct rainfall. **SUITABLE FOR EITHER DRY OR DAMP LOCATIONS.**
- **Save these instructions.**

WARNING:

- **To reduce the risk of fire, electrical shock or personal injury, always turn off light fixture and allow it to cool prior to replacing light bulb.**
- **Do not touch bulb when fixture is turned on. Do not look directly at lit bulb.**
- **Keep flammable materials away from lit bulb.**
- **This lighting fixture contains lead, a chemical known to the State of California to cause cancer, birth defects and other reproductive harm. Wash hands after installing, handling, cleaning or otherwise touching this light fixture.**

Pre-assembly:

- Remove all parts and hardware from box along with any plastic protective packaging.
- Do not discard any contents until after assembly is complete to avoid accidentally discarding small parts or hardware.
- For your safety and convenience, assembly by two people is recommended.

TOOLS REQUIRED (not included):

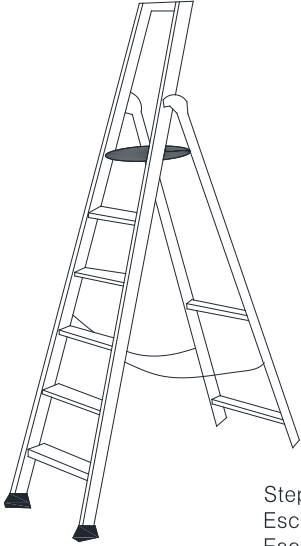
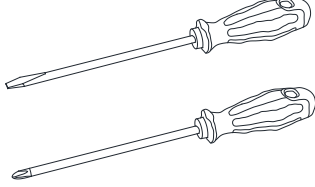
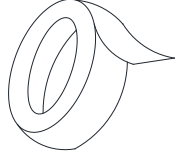
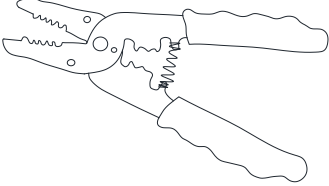
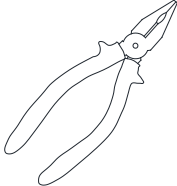
 <p>Step Ladder Escabeau Escalera</p>	 <p>Phillips Head, Flat Blade Screwdrivers Tournevis à tête Phillips et à tête plate Destornilladores Cabeza Phillips y Destornilladores Cabeza Plana</p>	 <p>Electrical tape Ruban isolant Cinta Electrica.</p>
	 <p>Wire Cutter/Stripper Pince coupe-fil/ à dénudé Cortador de Cable</p>	 <p>Plier Pince Alicates</p>



Parts Included:

- (A) Mounting Plate (1)
- (B) Canopy (1)
- (C) Canopy Nut (1)
- (D) Fixture Loop (1)
- (E) Threaded Tube (1)
- (F) Hanging Loop (1)
- (G) 18" Connection tubes (2)
- (H) 12" Connection tubes (2)
- (I) 6" Connection tubes (2)
- (J) Connectors (5)
- (K) Joint (1)
- (L) Light fixture (1)
- (M) Hex Nut (1)
- (Q) Closable Link (1)
- (R) Socket (1)
- (S) Shade (1)

Hardware Enclosed:

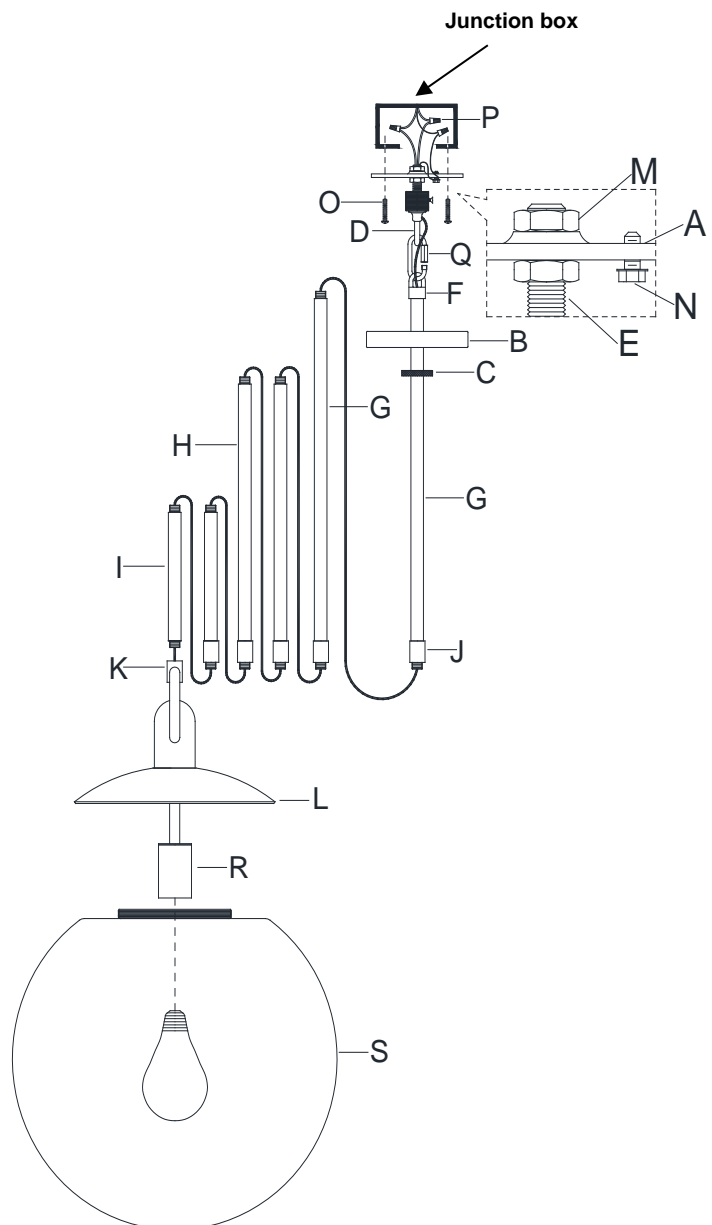
- (N) Green Ground Screw (1)
- (O) Mounting Screws (2)
- (P) Plastic Wire Nut Connectors (3)



 <p>Mounting Screws 3X</p>	 <p>Plastic Wire Nut Connectors 3X</p>	 <p>Green Ground Screw 1x</p>
---	--	--

To adjust the suspension length of the fixture:

1. Note: The adjustment or shortening of the lighting fixture's suspension length is only needed if the factory set length is not appropriate for your installation. We recommend that you adjust the Connection Rod quantity to the proper desired length before cutting the electrical cord. Determine the lighting fixture suspension length from the ceiling for the product installation, allowing the extra cord length for the outlet junction box wire connections as noted below.
2. (See A1,A2 ,A3 &A4) Thread the fixture 2 wire cord, bare copper wire through the 6" Connection tubes (I), thread one end of the 6" Connection Tube (I) into the Joint (K) by rotating clockwise until tight. Use the Additional Tubes (G/H/I/J) as needed, to adjust the fixture's suspension length by following the procedures as shown in illustration A2, A3 &A4.

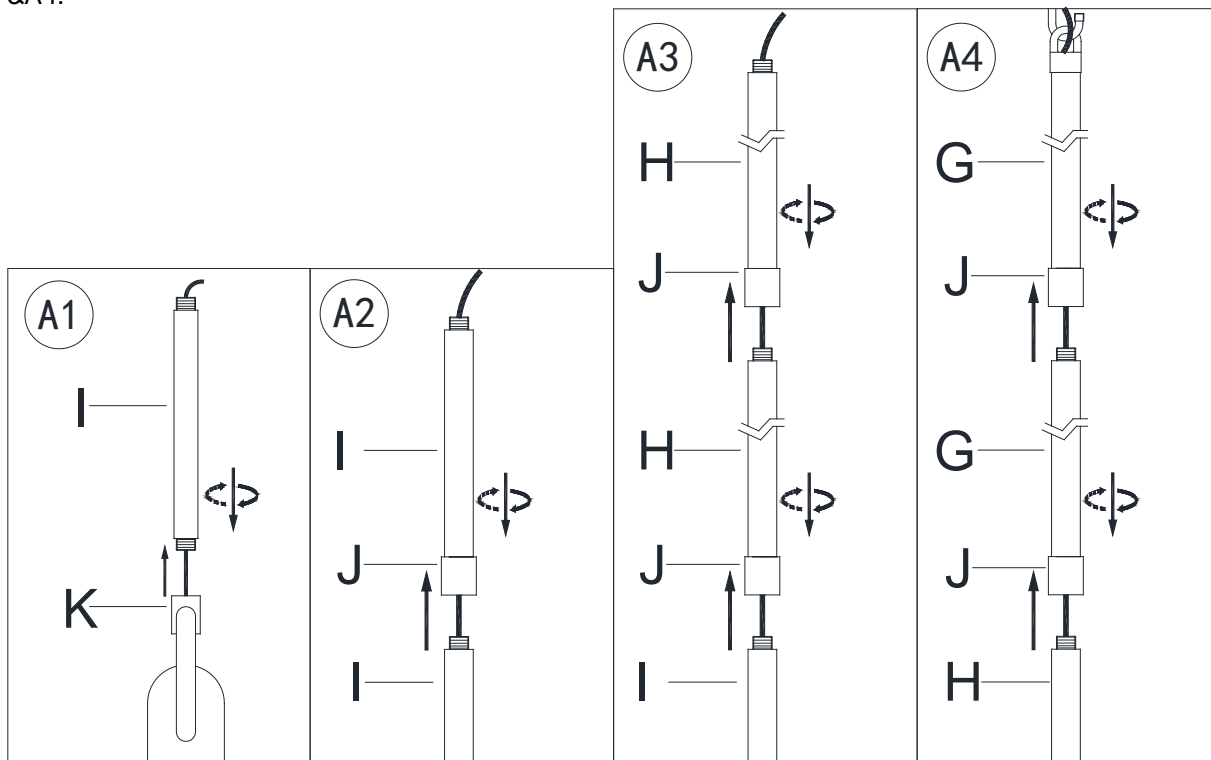

3. (See A5) If needed, cut off the extra power cord length on the 2 wire cord and bare ground wire so that they all are at least 6 inches (152.4 mm) long within the outlet junction box (J-box).

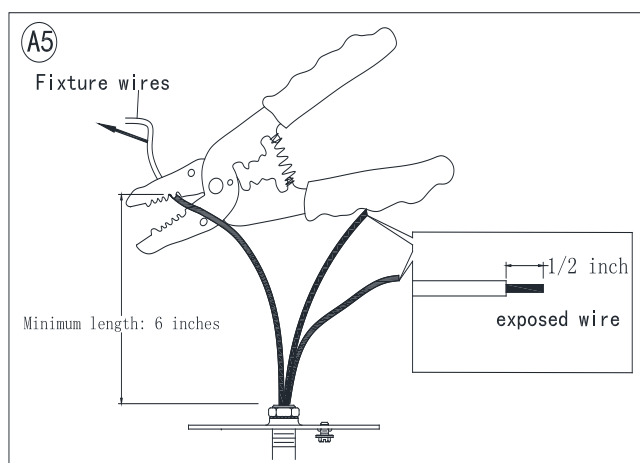

Assembly & Installation Instructions:

- **SHUT OFF THE MAIN ELECTRICAL SUPPLY FROM THE MAIN FUSE BOX/CIRCUIT BREAKER.**
- Carefully unpack all fixture parts and hardware and lay them on a clear workspace.

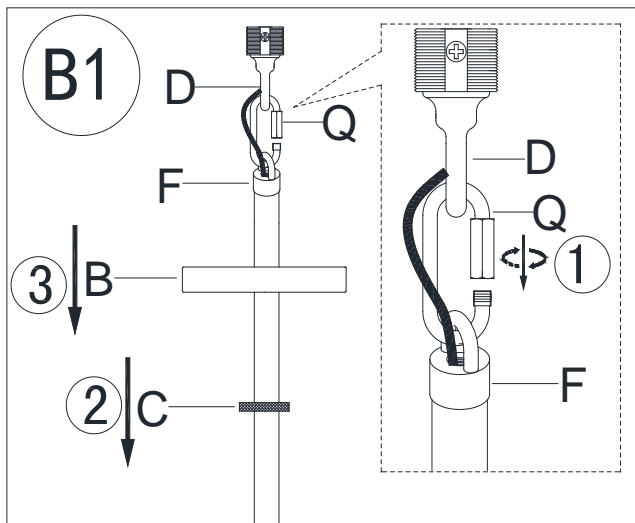

1. Hang chandelier by joining Fixture Loop (D), Closable Link (Q), and Hanging Loop (F) together. Secure by tighten the Closable Link (Q).
2. Slide the Canopy Nut (C) over the upper end of Connection Tube (G).
3. Slide the Canopy (B) over the Connection Tube (G).

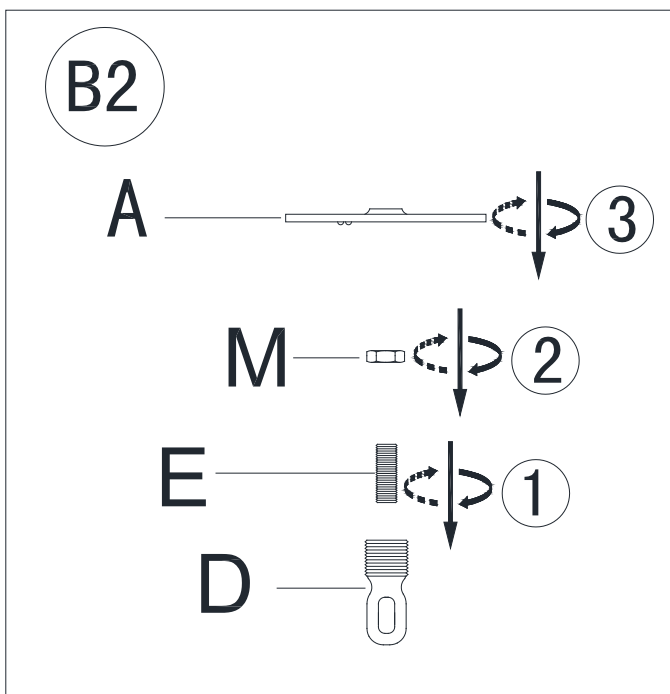

1. Attach the Threaded Tube (E) into the threaded bore of the Hanging Loop (D) and rotate the Threaded Tube (E) clockwise until it is tightly engaged within the Hanging Loop (D).
2. Screw Hex Nut (M) to Threaded Tube (E).
3. Attach the Mounting Plate (A) onto the top end of the Threaded Tube (E) so that a portion of the Threaded Tube (E) extends beyond the Mounting Plate (A).

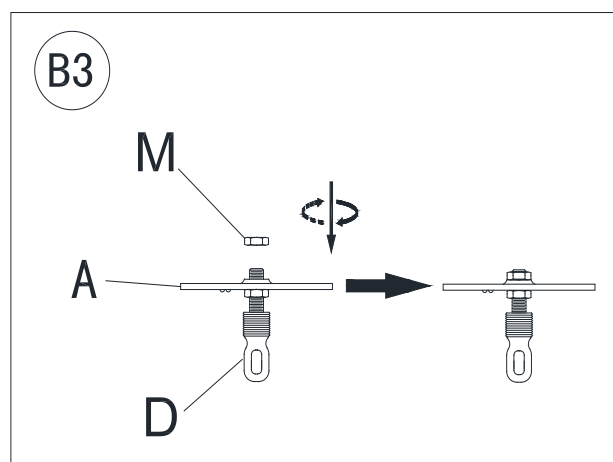

1. Position the Lock Washer (L) first and then the Hex Nut (M) onto the top end of Threaded Tube (E). Tighten the Hex Nut (M) until tight using pliers so that the Hanging Loop (D) is now firmly secured to the middle of the Mounting Plate (A).

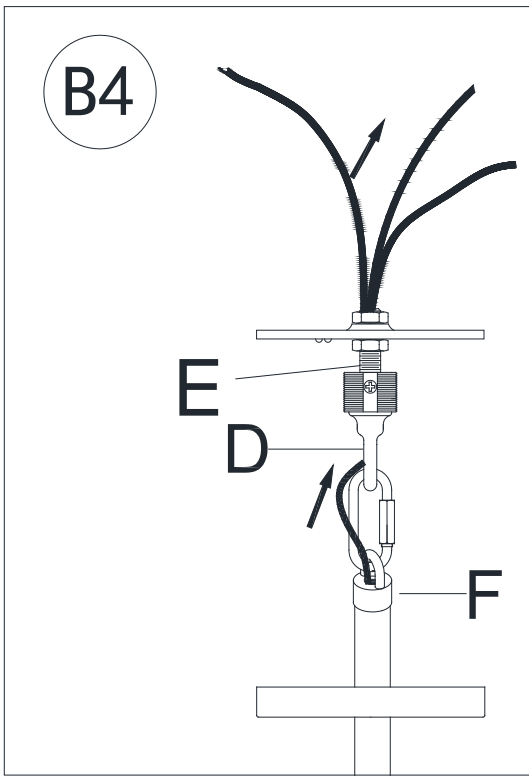

Feed the fixtures power cord and bare ground wire and Steel Cable through Hanging Loop (F) and Threaded Tube (E).

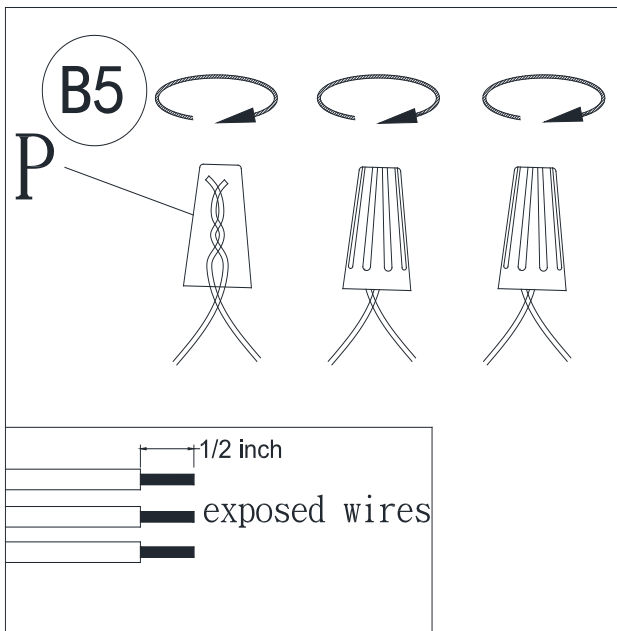

Please read the section "To Make the Wire Connections" Below.

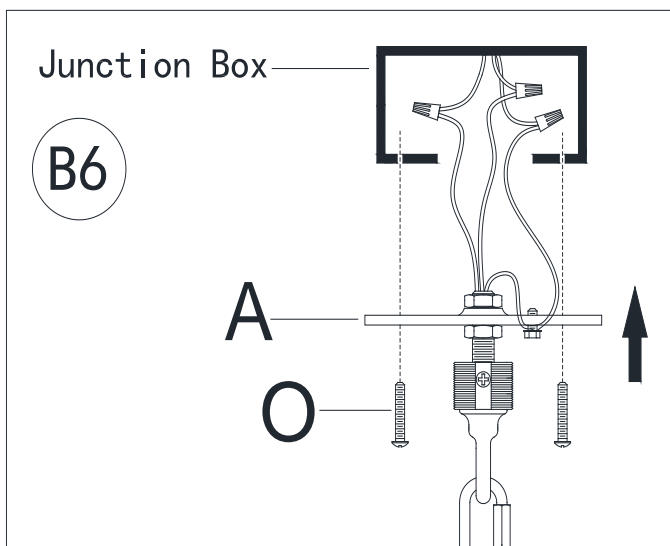

Attach the Mounting Plate (A) onto the junction box using Mounting Screws (O).

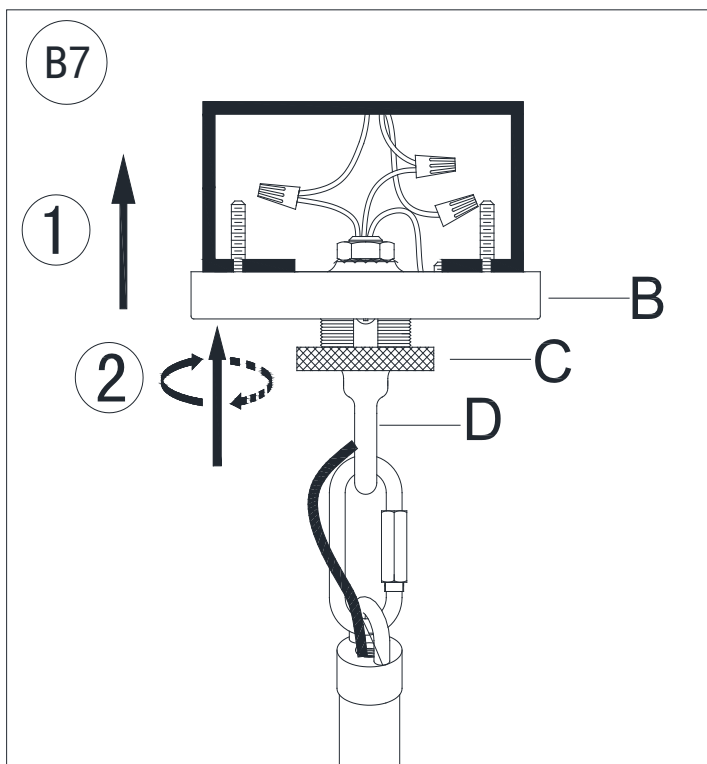

Slide the Canopy (B) upward along the Connection Tube (G) with the upper rim of the canopy pressed gently against the ceiling surface. Position the Canopy Nut (C) against the Fixture Loop (D) and rotate the nut clockwise to engage it with the threaded portion of the Fixture Loop (D) until secure. Do not over tighten this nut.

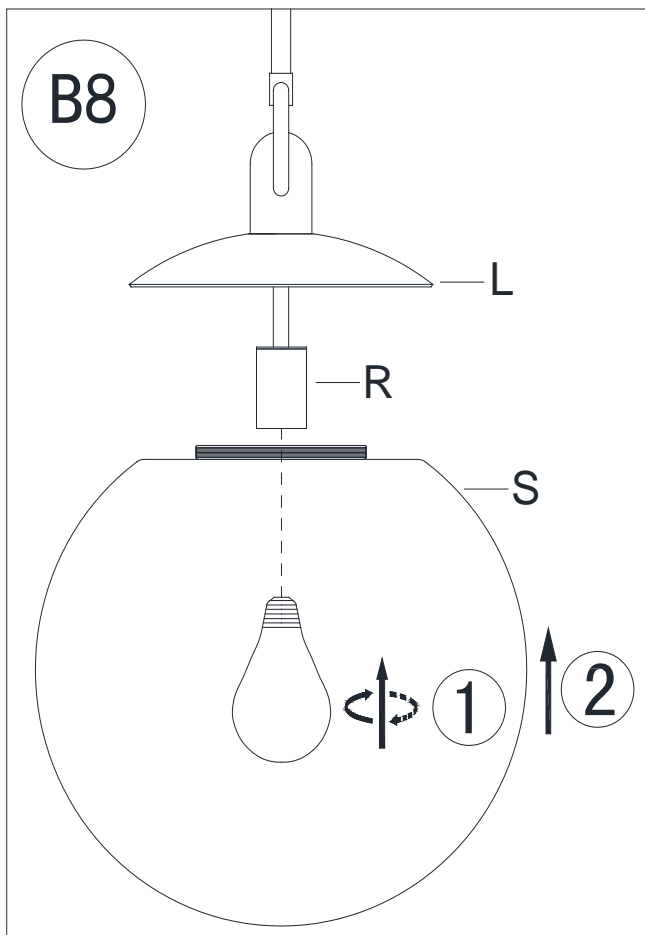

1. Insert the specified light bulb into the Socket (R).
DO NOT EXCEED THE SPECIFIED WATTAGE.
2. Attach the Shade (S) to the Light Fixture (L) and rotate the shade clockwise to engage it with the threaded portion of the Light Fixture (L) until secure. Do not over tighten.

To Make the Wire Connections:

1. Gently pull existing wire down from the ceiling junction box and allow wires to hang. The HOT or LIVE wire is usually black. The NEUTRAL wire is usually white. Check to see if there is a ground wire that is usually green or green with a yellow stripe or exposed copper metal wire. If needed, use a pair of wire strippers to remove about 1/2 inch of insulation from each wire.

- Carefully inspect the fixture wires. The NEUTRAL FIXTURE WIRE has FINE LONGITUDINAL RIDGES running along its length. The HOT FIXTURE WIRE is SMOOTH and the BARE COPPER WIRE is the GROUND WIRE. If you have any doubt and cannot identify the power-supply wires with confidence, then we recommend that you ask an electrician and that you not continue with the installation.
- With the help of another person to hold the weight of the fixture, attach the fixture wires to the junction box wires as shown in the illustrations.

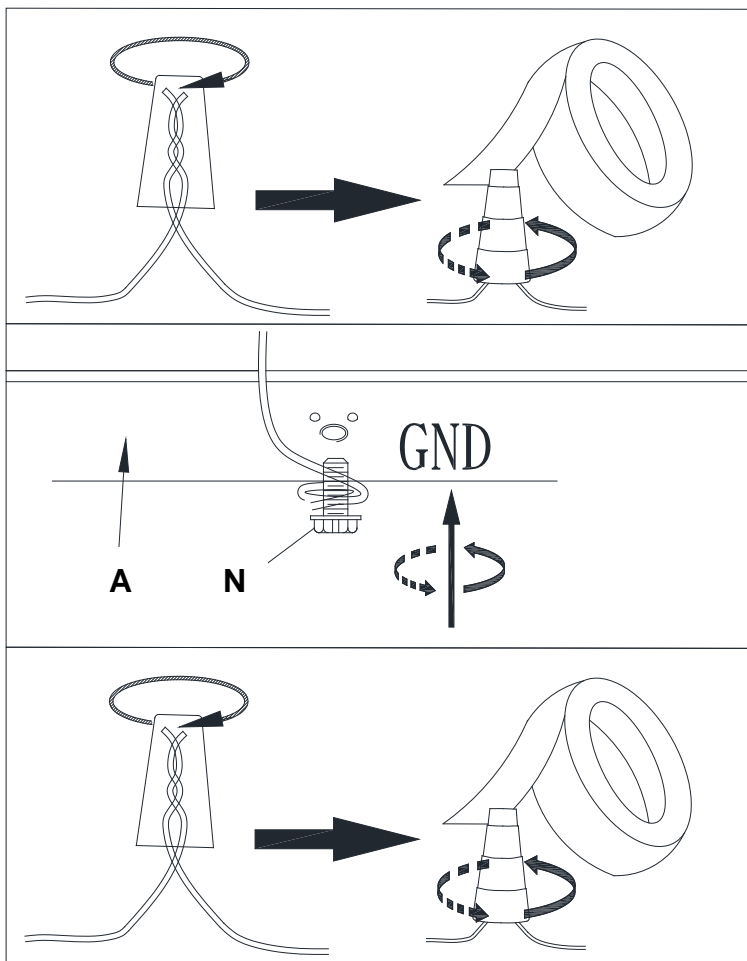

Connect the GROUND FIXTURE WIRE to the GROUND J-BOX WIRE using the Plastic Wire Nut Connector (P) and wrap the connection with electrical tape. Be sure that no wire strands are exposed.

If the junction box DOES NOT have a GROUND WIRE, wrap the fixture's bare ground wire around the Green Ground Screw (N) and insert the screw into the Mounting Plate (A), marked as "GND", and tighten screw to secure the wire.

Connect the NEUTRAL FIXTURE WIRE to the NEUTRAL J-BOX WIRE first and then connect the HOT FIXTURE WIRE to the HOT J-BOX WIRE using the Plastic Wire Nut Connectors (P). Wrap these connections with electrical tape. Be sure that no wire strands are exposed.

NOTE:

**IT IS IMPERATIVE THAT THE JUNCTION BOX IN YOUR HOME BE PROPERLY GROUNDED!
DO NOT REVERSE THE HOT AND NEUTRAL CONNECTIONS OR SAFETY WILL BE COMPROMISED.**

- Check the wiring connections and if all looks good, gently tuck the wire connections neatly into the ceiling junction box.

Care instructions:

- Wipe clean with a soft, dry cloth or static duster.
- Always avoid the use of harsh chemicals or abrasive cleaners as they may cause damage to the fixture's finish.

Thank you for your purchase

Stores | catalog | www.williams-sonoma.com

USA 1.877.812.6235