



English
繁體中文

Incanto

Type HD8911

 **Saeco**

Register your product and get support at
www.saeco.com/care

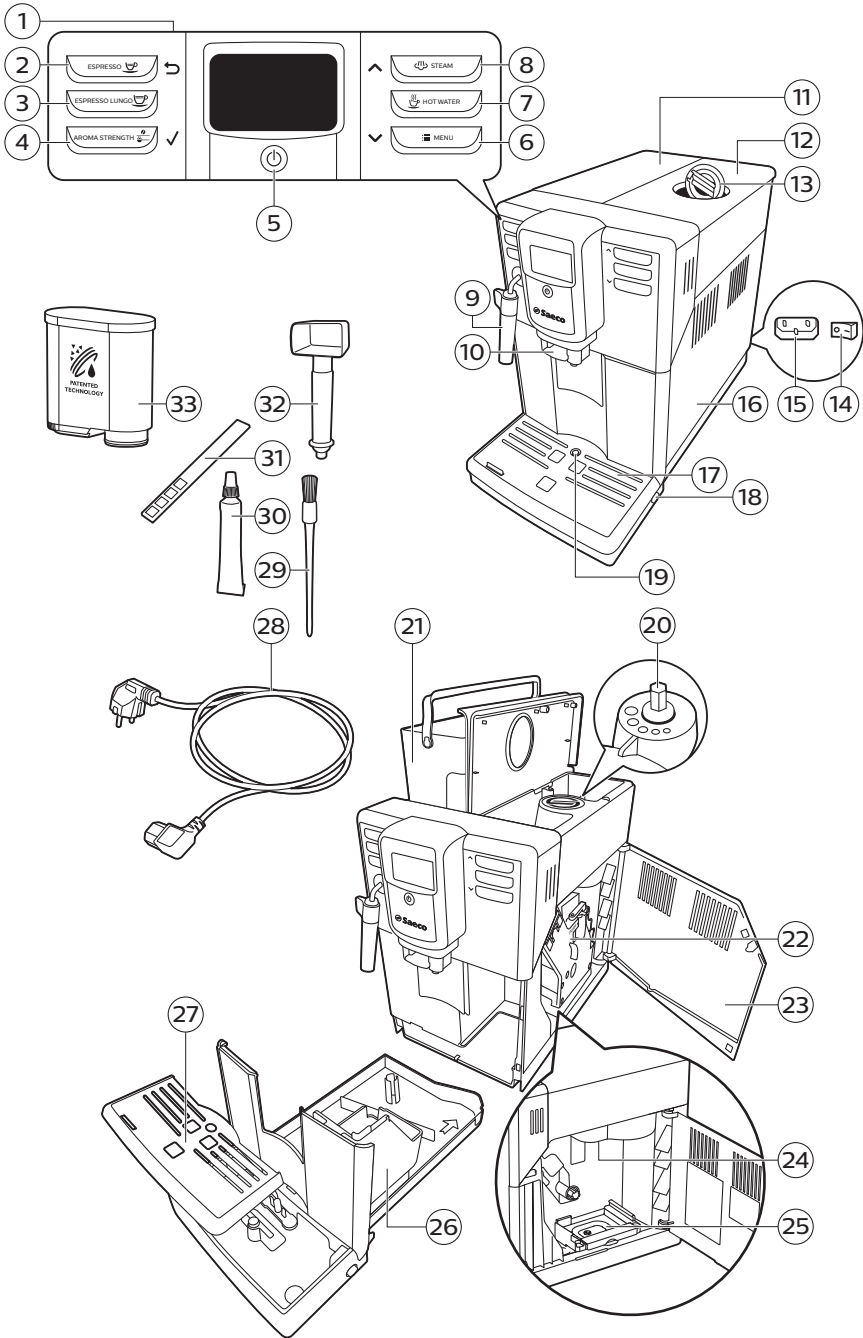

Contents

Introduction	5
Important	5
Electromagnetic fields (EMF)	6
Machine overview	6
The user interface	7
First installation	8
Manual rinsing cycle	10
Hot water circuit rinsing	10
Coffee brewing circuit rinsing	10
Intenza+ water filter	10
Installing the Intenza+ water filter	10
Replacing the Intenza+ water filter	11
Measuring the water hardness	12
Setting the water hardness	12
Beverage types and lengths	13
Brewing coffee	13
Adjusting the coffee dispensing spout	13
Brewing coffee with beans	13
Brewing 1 cup of coffee	13
Brewing 2 cups of coffee	13
Brewing coffee with pre-ground coffee	14
Frothing milk	14
Hot water	15
Adjusting quantity and taste	15
Saeco Adapting System	15
Adjusting coffee length	15
Adjusting coffee strength	16
Adjusting the grinder settings	16
Maintenance and care	17
Cleaning the drip tray and the coffee grounds container	17
Cleaning the water tank	17
Cleaning the bean hopper	17
Cleaning the brew group and the coffee exit duct	17
Weekly cleaning of the brew group	17
Monthly cleaning of the brew group	19
Lubrication of the brew group	20
Cleaning the classic milk frother	21
Daily cleaning of classic milk frother	21
Weekly cleaning of classic milk frother and steam wand	21
Descaling procedure	21
What to do if the descaling procedure is interrupted	23
Warning icons and error codes	23
Meaning of error codes	24
Troubleshooting	25
Demo mode function	29
Ordering accessories Saeco	29

Technical specifications	29
Disposal	30
Warranty and support	30

Introduction

Dear customer, we thank you for buying the Saeco Incanto full-automatic espresso machine!

Coffee is a natural product and its characteristics may vary according to origin, blend and roasting. The machine is equipped with a self-adjustment system that allows it to get the best taste out of your favorite coffee beans. It regulates itself after brewing 10-20 coffees.

In this user manual you find all the information you need to install, use, maintain and get the best out of your machine. To fully benefit from the support that Saeco offers, please register your product at www.saeco.com/welcome.

Important

This machine is equipped with safety features. Nevertheless, read and follow the safety instructions carefully and only use the machine as described in these instructions, to avoid accidental injury or damage due to improper use of the machine. Keep this user manual for future reference.

- Connect the machine to a wall socket with a voltage matching the technical specifications of the machine.
- Connect the machine to an earthed wall socket.
- Do not let the power cord hang over the edge of a table or counter, or touch hot surfaces.
- Never immerse the machine, mains plug or power cord in water (danger of electrical shock).
- Do not pour liquids on the power cord connector.
- Never direct the hot water jet towards body parts: danger of burns.
- Do not touch hot surfaces. Use handles and knobs.
- Switch off the machine with the main switch located on the back and remove the mains plug from the socket:
 - If a malfunction occurs.
 - If the machine will not be used for a long time.
 - Before cleaning the machine.
- Pull on the plug, not on the power cord.
- Do not touch the mains plug with wet hands.
- Do not use the machine if the mains plug, the power cord or the machine itself is damaged.
- Do not make any modifications to the machine or its power cord.
- Only have repairs carried out by a service center authorized by Philips to avoid a hazard
- The machine should not be used by children younger than 8 years old.

- This machine can be used by children aged from 8 years and above and by persons with reduced physical, sensory or mental capabilities or lack of experience and knowledge if they have been given supervision or instruction concerning use of the machine in a safe way and if they understand the hazards involved.
- Cleaning and user maintenance shall not be made by children unless they are older than 8 and supervised.
- Keep the machine, its accessories and its cord out of the reach of children aged less than 8 years.
- Children should be supervised to ensure that they do not play with the machine.
- Never insert fingers or other objects in the coffee grinder.
- The machine shall not be placed in a cabinet when in use.
- This machine is intended for normal household use only. It is not intended for use in environments such as staff kitchens of shops, offices, farms or other work environments.
- Always put the machine on a flat and stable surface. Keep it in upright position, also during transport.
- Do not place the machine on a hotplate or directly next to a hot oven, heater or similar source of heat.
- Only put roasted coffee beans in the bean hopper. If ground coffee, instant coffee, raw coffee beans or any other substance is put in the coffee bean hopper, it may cause damage to the machine.
- Let the machine cool down before inserting or removing any parts. The heating surfaces may retain residual heat after use.
- Never fill the water tank with warm, hot or sparkling water, as this may cause damage to the water tank and the machine.
- Never use scouring pads, abrasive cleaning agents or aggressive liquids such as petrol or acetone to clean the machine. Simply use a soft cloth dampened with water.
- Descale your machine regularly. The machine indicates when descaling is needed. Not doing this will make your appliance stop working properly. In this case repair is not covered under your guarantee.
- Do not keep the machine at temperatures below 0°C. Water left in the heating system may freeze and cause damage.
- Do not leave water in the water tank when the machine is not used over a long period of time. The water can be contaminated. Use fresh water every time you use the machine.

Electromagnetic fields (EMF)

This Philips appliance complies with all applicable standards and regulations regarding exposure to electromagnetic fields.

Machine overview

- 1 User interface
- 2 ESPRESSO button
- 3 ESPRESSO LUNGO button
- 4 AROMA STRENGTH button

- 5 Standby button
- 6 MENU button
- 7 HOT WATER button
- 8 STEAM button
- 9 Classic milk frother
- 10 Adjustable coffee dispensing spout
- 11 Lid of the water tank
- 12 Lid of the bean hopper
- 13 Lid of the pre-ground coffee compartment
- 14 Main switch
- 15 Socket for cord
- 16 Service door
- 17 Drip tray
- 18 Drip tray release button
- 19 Drip tray full indicator
- 20 Grinder adjustment knob
- 21 Water tank
- 22 Brew group
- 23 Inside of service door with cleaning instructions
- 24 Coffee exit duct
- 25 Coffee residues drawer
- 26 Coffee grounds container
- 27 Drip tray cover
- 28 Cord
- 29 Cleaning brush
- 30 Grease
- 31 Water hardness tester
- 32 Multifunctional tool (measuring scoop, grinder adjustment key and coffee duct cleaning tool)
- 33 AquaClean filter

The user interface



Use these buttons to navigate through the menus:

ESPRESSO button = ESC button: press this button to return to the main menu.



AROMA STRENGTH button = OK button: press this button to select, confirm or stop a function.



STEAM button = UP button: press this button to scroll up through the display menu.



MENU button = DOWN button: press this button to scroll down through the display menu.

First installation

This machine has been tested with coffee. Although it has been carefully cleaned, there may be some coffee residues left. We guarantee, however, that the machine is absolutely new. Like with most full-automatic machines, you first need to brew some coffees to enable the machine to complete its self-adjustment and get the best tasting coffee.

- 1 Remove all packaging material from the machine.
- 2 Place the machine on a table or counter away from the faucet, the sink and heat sources.

Note: Leave at least 15 cm of free space above, behind and on both sides of the machine.

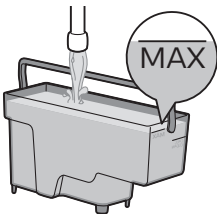
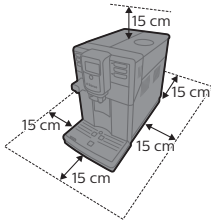

- 3 Fill the water tank with fresh water to the MAX level indication.

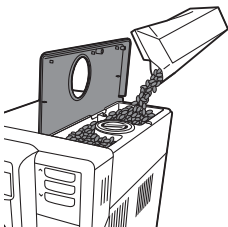

- 4 Open the lid of the bean hopper. Fill the bean hopper with coffee beans and close the lid.

Note: Do not overfill the bean hopper to avoid damage to the grinder.

Caution: Only use espresso beans. Never use ground coffee, unroasted coffee beans or caramelized coffee beans, as this may cause damage to the machine.

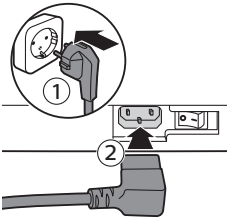

- 5** Insert the power plug into a wall outlet (1) and insert the small plug into the socket located on the back of the machine (2).

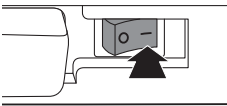

- 6** Set the main switch to the ON position to turn on the machine. The standby button flashes.

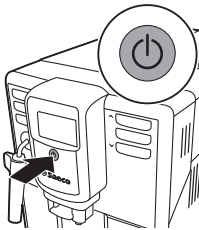

- 7** Press the standby button to turn on the machine.



- The display shows the circuit priming icon to indicate that you have to prime the circuit.

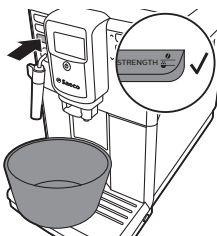

- 8** Place a container under the classic milk frother. Press the OK button to start the water circuit priming cycle.

- The machine starts dispensing hot water.
- The display shows the priming icon. The progress bar shows the progress of the priming cycle.

- 9** The machine heats up and the display shows the temperature icon.

- 10** Empty the container and place it under the coffee dispensing spout.



- 11** The machine starts rinsing water through the coffee dispensing spout. The display shows the rinsing icon and a progress bar.

Note: Do not interrupt the rinsing cycle.

The machine is now ready for use.

Manual rinsing cycle

During the manual rinsing cycle, fresh water flows through the water and coffee brewing circuit. This takes a few minutes.

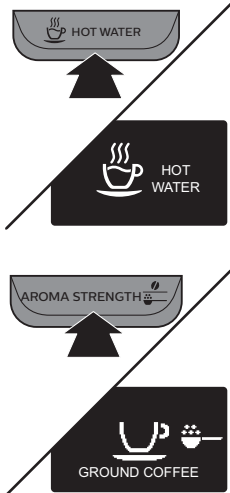

Hot water circuit rinsing

- 1 Place a container under the classic milk frother.
- 2 Press the HOT WATER button.
 - The machine starts dispensing hot water.

Note: To interrupt the rinsing cycle, press the OK button.

- 3 When the machine has dispensed 2 cups of hot water (0.5 l), press the OK button to stop the hot water dispensing. Repeat steps 1 to 3 twice.

Coffee brewing circuit rinsing

- 1 Place a container under the coffee dispensing spout.
- 2 Press the AROMA STRENGTH button and select the pre-ground coffee brewing function.

Note: Do not add pre-ground coffee in the pre-ground coffee compartment.

- 3 Press the ESPRESSO LUNGO button.
 - The machine starts dispensing water from the coffee dispensing spout.
- 4 Wait until the machine stops dispensing water and empty the container.
- 5 Repeat steps 1 to 4 twice.
- 6 When the machine has returned to the main menu, empty the container. The machine is ready for use.

Intenza+ water filter

We advise you to install the Intenza+ water filter to reduce limescale deposits in your coffee machine and to provide filtered water for preserving the aroma and flavor of each cup of coffee.

Installing the Intenza+ water filter

Note: Always confirm activation of the Intenza+ water filter in the machine menu as described below. By activating the Intenza+ water filter in the machine menu, the machine indicates when you need to replace the filter.

- 1 Remove the small white filter from the water tank and store it in a dry place.

Note: Please keep the small white filter for future use. You will need it for the descaling process.

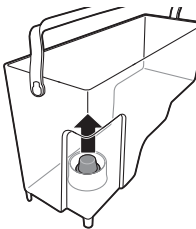



- 2 Remove the filter from its packaging and immerse it in cold water with the opening pointing upwards. Press the sides of the filter gently to let out the air bubbles.

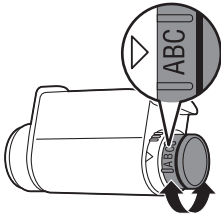

- 3 Turn the knob of the filter to the setting that corresponds to the water hardness of the area you live in.
 - a Very soft water/soft water
 - b Hard water (default)
 - c Very hard water

Note: You can test the water hardness with a water hardness test strip.

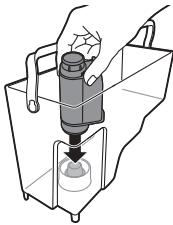

- 4 Place the filter in the empty water tank. Press it down until it cannot move any further.
- 5 Fill the water tank with fresh water up to the MAX indication and slide it into the machine.
- 6 Press the MENU button and scroll to INTENZA+ FILTER. Press the OK button to confirm.



- 7 Select ON on the display, press the OK button to confirm activation.
- 8 Dispense 2 cups of hot water (0.5l) to complete the activation. Discard this water.

Replacing the Intenza+ water filter

Note: Replace the Intenza+ water filter as soon as the filter icon appears on the display.



- 1 Take out the water filter and replace it by a new Intenza+ water filter. Follow the instructions (see 'Intenza+ water filter') on how to prepare the water filter for use.
- 2 Press the MENU button and scroll to INTENZA+ FILTER. Press the OK button to confirm.
- 3 Select RESET on the display, press the OK button to confirm reactivation.
- 4 Dispense 2 cups of hot water (0.5 l) to complete the activation of the new filter. Discard this water.



Measuring the water hardness

To be able to adjust the machine settings to the water in your region, please measure the water hardness with the water hardness strip supplied.



- 1 Immerse the water hardness test strip (supplied with the machine) in tap water for 1 second.
- 2 Remove the water hardness strip and and wait for 1 minute.

- 3 Check how many squares have changed into the red colour and check the water hardness in below table.

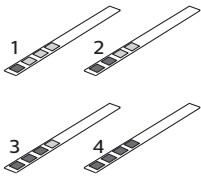

numbers of red squares	value to be set	water hardness
1	1	very soft water
2	2	soft water
3	3	hard water
4	4	very hard water

Setting the water hardness

Setting the water hardness

- 1 To set the water hardness, press the MENU button, select menu and scroll to select WATER HARDNESS.
- 2 Press the OK button and select the water hardness in your area.
- 3 Press the OK button to confirm.
- 4 Press the ESC button to return to the main menu.



Beverage types and lengths

Beverage name	Description	How to select
Espresso	Coffee with thick crema served in a small cup	Button on control panel
Espresso Lungo	A longer espresso with thick crema served in a medium-sized cup	Button on control panel
Hot Water		Button on control panel

Beverage name	Standard length	Length range
Espresso	40 ml	20 - 230 ml
Espresso Lungo	120 ml	20 - 230 ml

Brewing coffee

Adjusting the coffee dispensing spout

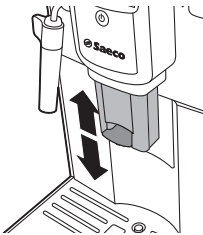

The machine can be used to dispense different coffee types in cups or glasses of different sizes. To adjust the height of the coffee dispensing spout to the size of the cup or glass, slide the spout up or down.

Brewing coffee with beans

Brewing 1 cup of coffee

- 1 Place a cup under the coffee dispensing spout.
- 2 Press the ESPRESSO or ESPRESSO LUNGO button to brew the selected coffee.
 - Coffee starts pouring from the coffee dispensing spout.

Note: If you want to stop the brewing process before the machine has finished dispensing the preset coffee volume, press the OK button.

Brewing 2 cups of coffee

- 1 Place two cups under the coffee dispensing spout.
- 2 You can brew two cups of espresso or espresso lungo simultaneously. Press the button of the desired beverage twice. The machine automatically carries out two grinding cycles in sequence.

Brewing coffee with pre-ground coffee

When you brew coffee with pre-ground coffee, use the measuring scoop in the multifunctional tool supplied to put the correct dose in the pre-ground coffee compartment. If you add more pre-ground coffee, the excess coffee will end up in the coffee grounds drawer.

- 1 Open the lid of the pre-ground coffee compartment.
- 2 Pour one measuring scoop of pre-ground coffee into the compartment.

Caution: Do not put any other substance than pre-ground coffee in the pre-ground coffee compartment, as this may damage the machine.

- 3 Close the lid of the pre-ground coffee compartment.
- 4 Place a cup under the coffee dispensing spout.
- 5 Press the AROMA STRENGTH button and select pre-ground coffee
 - The machine automatically starts brewing the selected beverage.

Note: You can only brew one coffee beverage at a time with pre-ground coffee.

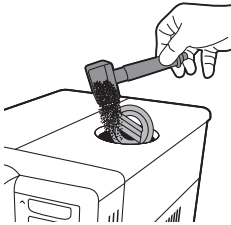

Frothing milk

Warning: Danger of scalding! Dispensing may be preceded by small jets of hot water. Use the appropriate protective handle only.

Note: Use cold milk (at a temperature of approximately 5°C/41°F) with a protein content of at least 3% to ensure an optimal frothing result. You can use whole milk or semi-skimmed milk. It is also possible to use skimmed milk, soy milk and lactose-free milk.

Note: We advise you to rinse the water circuit before use. Press the STEAM button to dispense steam for a few seconds.

- 1 Fill 1/3 of a jug with cold milk.
- 2 Immerse the classic milk frother in milk. Press the STEAM button.

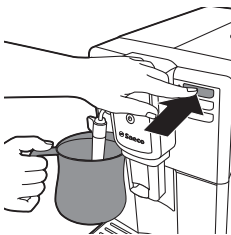

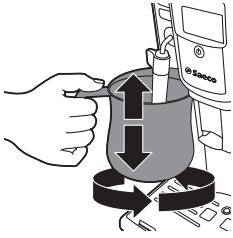

- 3 Froth the milk by gently swirling the jug and moving it up and down.
- 4 Press the OK button to stop frothing.

Hot water

Warning: Danger of scalding! Dispensing may be preceded by small jets of hot water. Use the appropriate protective handle only.

- 1 Place a jug under the classic milk frother.
- 2 Press the HOT WATER button. Hot water dispensing starts automatically.
- 3 Press the OK button to stop hot water dispensing.

Adjusting quantity and taste

Saeco Adapting System

Coffee is a natural product and its characteristics may vary according to origin, blend and roasting. The machine is equipped with a self-adjustment system that allows it to get the best taste out of your favorite coffee beans. It regulates itself after brewing some coffees.

Adjusting coffee length

You can adjust the quantity of beverage brewed according to your taste and to the size of the cups.

- 1 To adjust the length of espresso, press and hold the ESPRESSO button until the display shows the MEMO icon.
 - The machine enters the programming phase and starts to brew the selected beverage.



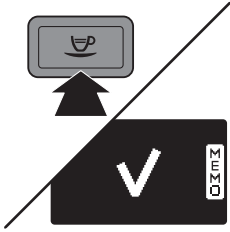

- 2 Press the OK button when the cup contains the desired amount of espresso.
 - The tick on the display shows that the button is programmed: every time it is pressed, the machine will brew espresso in the amount set. To set the length of espresso lungo, follow the same procedure: press and hold the button of the beverage and press the OK button when the desired amount is in the cup.

Adjusting coffee strength

To change the coffee strength, press the AROMA STRENGTH button. Each time you press the AROMA STRENGTH button, the aroma strength changes by one degree. The display shows the chosen strength, which will only be saved when brewing a coffee.

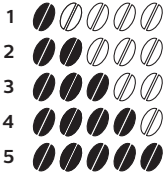

- 1 Very mild
- 2 Mild
- 3 Regular
- 4 Strong
- 5 Very strong

Note: The machine will automatically dispense the correct quantity of coffee for each coffee strength.

GROUND COFFEE is the last option in the coffee strength menu. Select this option to brew coffee with ground coffee. Use the measuring scoop integrated in the multifunctional tool supplied to dose the correct quantity of ground coffee.

Note: The machine returns to the main screen and saves the chosen aroma strength when you brew a coffee.

Adjusting the grinder settings

You can adjust the grinder settings with the grinder adjustment key integrated into the handle of the multifunctional tool. At each setting selected, the ceramic coffee grinder guarantees a perfectly even grind for every cup of coffee you brew. It preserves the full coffee aroma and delivers the perfect taste to every cup.

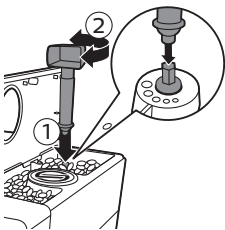

- 1 Open the lid of the bean hopper.
- 2 Place the grinder adjustment key on the grinder adjustment knob (1). Push and turn to the left or to the right (2) one notch at a time.
 - There are 5 different grinder settings you can choose from. The smaller the dot the stronger the coffee.

Caution: Do not turn the grinder adjustment knob more than one notch at a time to prevent damage to the grinder.

Note: The difference becomes noticeable after you have brewed 2-3 cups of coffee at the new setting.

Maintenance and care

Maintenance of your machine is important to prolong the life of your machine and to ensure optimum quality and taste of your coffee.

Cleaning the drip tray and the coffee grounds container

Perform the following actions while the machine is turned on:

- When the display shows the 'empty coffee grounds container' icon, empty the coffee grounds container.
- The drip tray is full when the drip tray full indicator pops up through the drip tray. Empty and clean the drip tray every day.

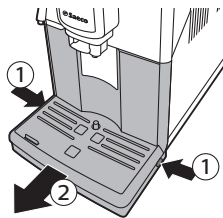
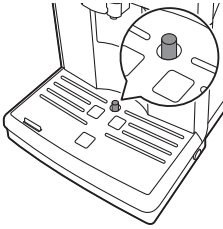

- 1 Turn the classic milk frother to the left.
- 2 Press the release buttons on both sides of the drip tray (1) and pull the drip tray out of the machine (2).
- 3 Remove and empty the coffee grounds container.
- 4 Empty and rinse the drip tray under the tap.
- 5 Place the coffee grounds container back in the drip tray.
- 6 Slide the drip tray back into the machine until it locks into position with a click.

Note: Make sure that the machine is still switched on when you remove the drip tray. If you switch off the machine before you remove the drip tray, the 'empty coffee grounds container' icon will be visible on the display when you switch on the machine again, even though the drip tray is empty.

Cleaning the water tank

- 1 Remove the water tank from the machine and rinse it with fresh water periodically.
- 2 Fill the water tank with fresh water up to the MAX level indication and place it back in the machine.

Cleaning the bean hopper

Clean the bean hopper with a dry cloth once a month.

Cleaning the brew group and the coffee exit duct

Weekly cleaning of the brew group

- 1 Turn off the machine and unplug it.
- 2 Remove the drip tray with the coffee grounds container.
- 3 Empty the drip tray and rinse it under running water.

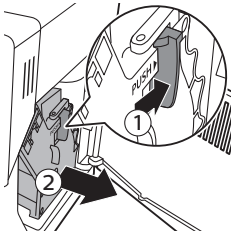

- 4 Empty the coffee grounds container and rinse it under lukewarm running water.
- 5 Open the service door.
- 6 Press the PUSH button (1) and pull at the grip of the brew group to remove it from the machine (2).

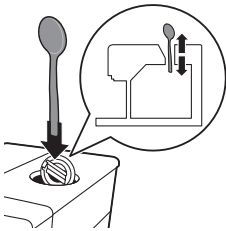

- 7 Clean the top part of the coffee exit duct thoroughly with a spoon handle. Insert it as indicated in the figure.

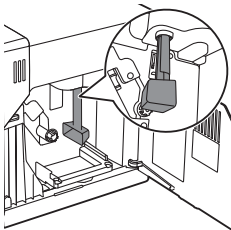

- 8 Clean the bottom part of the coffee exit duct thoroughly with a spoon handle or with the multifunctional tool provided with the machine. Insert it as indicated in the figure.

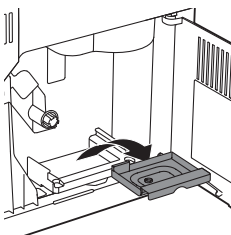

- 9 Remove the coffee residues container, empty it and rinse it under lukewarm running water. Let it dry and then reinsert it.

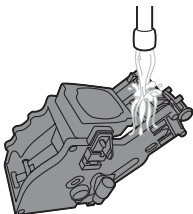

- 10 Rinse the brew group thoroughly under lukewarm running water. Clean the upper filter carefully.

Caution: Do not clean the brew group in the dishwasher and do not use dishwashing liquid or a cleaning agent to clean it. This may cause the brew group to malfunction and may have a negative effect on the coffee taste.

- 11 Let the brew group air-dry thoroughly.

Note: Do not dry the brew group with a cloth to prevent fibers from collecting inside the brew group.

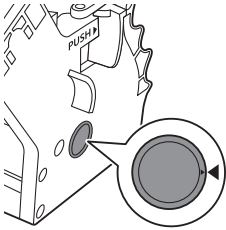

- 12 Clean the inside of the machine with a soft damp cloth.
- 13 Before you slide the brew group back into the machine, make sure the two reference signs on the side match. If they do not match, perform the following step:

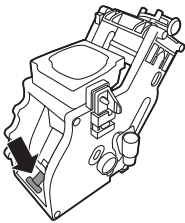

- Make sure the lever is in contact with the base of the brew group.
- 14 Make sure that the locking hook of the brew group is in the correct position.

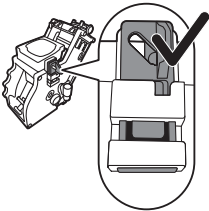

- To position the hook correctly, push it upwards until it is in uppermost position.

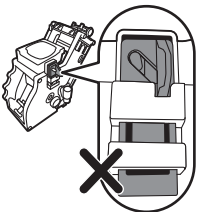

- The hook is not correctly positioned if it is still in bottommost position.
- 15 Slide the brew group back into the machine along the guiding rails on the sides until it locks into position with a click.

Caution: Do not press the PUSH button.

- 16 Close the service door.

Monthly cleaning of the brew group

- Perform this cleaning cycle after the machine has brewed 500 cups of coffee or once a month.
- Use a degreasing tablet for this cleaning cycle.

Caution: Only use degreasing tablets for cleaning. They do not have a descaling function.

- 1 Place a container under the coffee dispensing spout.
- 2 Press the AROMA STRENGTH button and select pre-ground coffee.

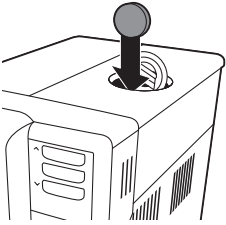

- 3 Put a coffee oil remover tablet in the pre-ground coffee compartment.
- 4 Press the ESPRESSO LUNGO button. The machine dispenses water from the coffee dispensing spout.
- 5 When the progress bar has reached the middle, set the main switch on the back of the machine to OFF.
- 6 Let the degreasing solution work for approximately 15 minutes.
- 7 Set the main switch to ON.
- 8 Press the standby button.
- 9 Wait until the machine performs an automatic rinsing cycle.
- 10 Perform the 'Weekly cleaning of the brew group' procedure.
- 11 Remove the drip tray with the coffee grounds container. Empty the drip tray and the coffee grounds container and place them back into the machine.
- 12 Press the AROMA STRENGTH button and select pre-ground coffee.
- 13 Press the ESPRESSO LUNGO button. The machine dispenses water from the coffee dispensing spout.
- 14 Repeat steps 12 and 13 twice. Discard the dispensed water.
- 15 To clean the drip tray, put a degreasing tablet in the drip tray and fill the drip tray up to two-thirds of its capacity with hot water. Let the degreasing tablet take effect for about 30 minutes. Then empty the drip tray and rinse it thoroughly.

Lubrication of the brew group

For optimal performance of the machine you have to lubricate the brew group. See table below for the lubrication frequency. For support visit our website: www.philips.com/support.

Type of usage	Nr of daily products	Lubrication frequency
Low	1-5	Every 4 months
Normal	6-10	Every 2 months
Heavy	>10	Monthly

- 1 Switch off the machine and unplug it.
- 2 Remove the brew group and rinse it under a lukewarm tap as described in section 'Weekly cleaning of the brew group'.
- 3 Apply a thin layer of grease around the shaft in the bottom of the brew group.

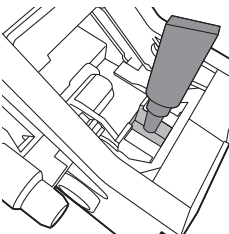

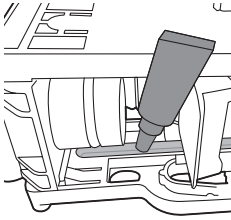

- 4 Apply a thin layer of grease to the rails on both sides (see figure).
- 5 Insert the brew group as described in section 'Weekly cleaning of the brew group'.

You can use the grease tube multiple times.

Cleaning the classic milk frother

Daily cleaning of classic milk frother

Remove the external part of the classic milk frother and rinse it with fresh water.

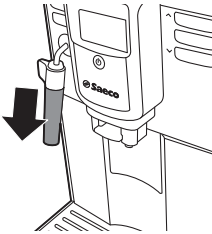

Weekly cleaning of classic milk frother and steam wand

- 1 Remove the external part of the classic milk frother and rinse it with fresh water.

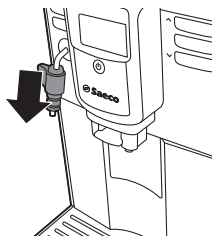

- 2 Remove the upper part of the classic milk frother from the steam wand and rinse it with fresh water.
- 3 Clean the steam wand with a wet cloth.
- 4 Reassemble all the classic milk frother parts.

Descaling procedure

When the display shows 'START CALC CLEAN', you need to descale the machine. If you do not descale the machine when this message appears on the display, the machine stop working properly. In that case, repairs are not covered by the warranty.

Only use Saeco descaling solution to descale the machine. Saeco descaling solution is designed to ensure optimal performance of the machine. The use of other products may damage the machine and leave residues in the water. You can buy Saeco descaling solution in the online shop at www.shop.philips.com/service. The descaling procedure lasts 30 minutes and consists of a descaling cycle and a rinsing cycle. You can pause the descaling or rinsing cycle by pressing the ESC button. To continue the descaling or rinsing cycle, press the OK button.

Note: Do not remove the brew group during the descaling procedure. Warning: Do not drink the descaling solution or the water dispensed during the descaling procedure.

- 1 Remove the drip tray and the coffee grounds container, empty and clean them and put them back into place.
- 2 Remove the external part of the classic milk frother.
- 3 Place a large container (1.5 l) under the coffee dispensing spout and the classic milk frother.
- 4 When the display shows 'START CALC CLEAN', press the OK button to start the descaling procedure. Remove the hot water dispensing spout if present.



- The following icon on the display reminds you to remove the Intenza+ water filter.



Note: You can press ESC to skip descaling. If you want to start the descaling procedure later, press the MENU button, select MENU and scroll to select DESCALING. Press OK to confirm.

- 5 Remove the water tank. If present, remove the Intenza+ water filter from the water tank and replace it with the original small white filter.
- 6 Pour the descaling solution in the water tank. Fill the water tank with fresh water up to the CALC CLEAN level indication. Place the water tank back in the machine. Press the OK button to confirm.
 - The first phase of the descaling procedure starts. The machine starts dispensing the descaling solution at intervals.
 - The display shows the descaling icon, the phase indication and the duration. This first phase takes 20 minutes.
- 7 Let the machine dispense the descaling solution until the water tank is empty.
- 8 Remove the water tank and rinse it.
- 9 Fill the water tank with fresh water up to the CALC CLEAN level indication. Place the water tank back in the machine and press OK.
- 10 Remove and empty the container and place it back under the coffee dispensing spout. Press OK to confirm.
- 11 The second phase of the descaling procedure starts, which is the rinsing cycle. This phase takes 3 minutes. The display shows the rinsing icon and the duration of the phase.

Note: If the water tank is not filled up to the CALC CLEAN level, the machine may require another rinsing cycle.

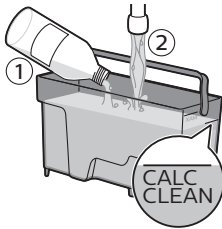



- 12 Wait until the machine stops dispensing water. The descaling procedure is finished when the tick appears on the display.
- 13 Press the OK button to exit the descaling procedure. The machine starts heating up and performs the automatic rinsing cycle.
- 14 Remove and empty the container.
- 15 Clean the classic milk frother after descaling.
- 16 Clean the brew group by performing the 'Weekly brew group cleaning' cycle.
- 17 Reinstall the Intenza+ water filter.

What to do if the descaling procedure is interrupted

Once the descaling procedure has started, you must complete it till the very end without switching off the machine. If the machine gets stuck during the cycle, you can exit the descaling procedure by pressing the standby button. If this occurs, or in case of a power failure or accidental disconnection of the cord, do the following:

- 1 Turn off the machine.
- 2 Empty and rinse the water tank thoroughly.
- 3 Fill the water tank up to the CALC CLEAN level indication and turn the machine back on.
 - The machine will heat up and perform an automatic rinsing cycle.
- 4 Before brewing any beverages, perform a manual rinsing cycle (see 'Manual rinsing cycle').

Note: If the descaling procedure was not completed, the machine will require another descaling procedure as soon as possible.

Warning icons and error codes

The warning icons are displayed in red. Below you find a list of the warning icons that may appear on the display and their meaning.



- Fill the water tank with fresh water to the MAX level indication.



- The bean hopper is empty. Put new coffee beans in the bean hopper.



- The brew group is not in the machine or it is not inserted properly. Insert the brew group.

24 English



- Insert the drip tray.

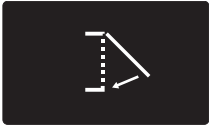

- Close the service door.



- Remove the coffee grounds container and empty it.



- When the filter icon appears on the display, you need to replace the Intenza+ water filter (see 'Replacing the Intenza+ water filter').



- If the display shows an error code, check section 'Meaning of the error codes' to see what the code on the display means and what you can do. The machine cannot be used when this icon is on the display.

- The lid of the bean hopper is open. Close the lid of the bean hopper.



Meaning of error codes

Error code	Problem	Cause	Possible solution
1	The coffee grinder is blocked.	The coffee exit duct is clogged.	Clean the coffee exit duct thoroughly with the handle of the multifunctional tool or a spoon handle.

Error code	Problem	Cause	Possible solution
3 - 4	There is a problem with the brew group.	The brew group is dirty.	Remove the brew group and thoroughly.
		The brew group is not positioned correctly.	Remove the brew group and reinsert it. Before you slide it back into the machine, make sure the two reference signs on the side match.
5	There is a water circuit problem.	There is air in the water circuit.	Remove and place back the water tank a couple of times. Make sure you insert it into the machine properly. Check if the water tank compartment is clean.
14	The machine is overheated.	This can have several causes.	Turn the machine off and turn it back on again after 30 minutes. Try this 2 or 3 times.

If the above solutions do not help to remove the error code icon from the display and bring the machine back to normal working order, contact the Philips Saeco hotline. Contact details can be found in the warranty booklet or on www.saeco.com/support.

Troubleshooting

This chapter summarizes the most common problems you could encounter with the machine. If you are unable to solve the problem with the information below, visit www.saeco.com/support for a list of frequently asked questions or contact the Consumer Care Center in your country.

Problem	Cause	Solution
The machine does not turn on.	The machine is disconnected or the main switch is in OFF position.	Check if the power cord is inserted correctly.
		Make sure the main switch is in ON position.
The machine is in DEMO mode.	The standby button has been pressed for more than 8 seconds.	Turn the machine off and then on again using the main switch on the back of the machine.
The drip tray fills up quickly.	This is normal. The machine uses water to rinse the internal circuit and brew group. Some water flows through the internal system directly into the drip tray.	Empty the drip tray when the 'drip tray full' indicator pops up through the drip tray cover.

Problem	Cause	Solution
The 'coffee grounds container full' icon remains displayed.	You emptied the coffee grounds container while the machine was turned off.	Place a cup under the dispensing spout to collect rinsing water. Always empty the coffee grounds container while the machine is ON. If you empty the coffee grounds container while the machine is turned off, the coffee cycle counter is not reset. In that case, the 'empty coffee grounds container' icon will stay on the display even though the container is not full.
I cannot remove the brew group.	You placed back the coffee grounds container too fast. The brew group is not in the correct position.	Do not place back the coffee grounds container until the display prompts you to put it back. Close the service door. Turn the machine off and back on again. Wait for the machine ready screen to appear and then remove the brew group. Clean the brew group.
I cannot insert the brew group.	You have not removed the coffee grounds container. The brew group is not in the correct position.	Remove the coffee grounds container before you remove the brew group. You did not put the brew group in neutral position before placing it back. Make sure that the lever is in contact with the base of the brew group and that the hook of the brew group is in the correct position.
The coffee has too little crema or is watery.	The machine is still in the descaling procedure. The grinder is set to a too coarse setting.	Reset the machine by turning it on and off. Place the drip tray and the coffee grounds container back. Leave the brew group out. Close the maintenance door and turn the machine on and off. Then try to reinsert the brew group. You cannot remove the brew group when the descaling process is active. First complete the descaling process and then remove the brew group.
	You are using an unsuitable coffee blend.	Adjust the grinder to a finer setting. Start using a different coffee blend.

Problem	Cause	Solution
	The machine is performing its self-adjustment.	Brew a few cups of coffee.
	The brew group is dirty.	Clean the brew group.
Coffee is leaking from the coffee dispensing spout.	The coffee dispensing spout is clogged.	Clean the coffee dispensing spout and its holes with a pipe cleaner.
The coffee is not hot enough.	The cups you use are cold.	Preheat the cups by rinsing them with hot water.
	The temperature is set too low. Check the menu settings.	Set the temperature to 'high' in the menu.
	You added milk.	Whether the milk you add is warm or cold, it always decreases the temperature of the coffee to some extent.
The machine grinds the coffee beans, but coffee does not come out.	The coffee exit duct is blocked.	Clean the coffee exit duct with the handle of the multifunctional tool or a spoon handle.
	The grind is set to a too fine setting.	Adjust the grinder to a coarser setting.
	The brew group is dirty.	Clean the brew group.
	The coffee dispensing spout is dirty.	Clean the coffee dispensing spout and its holes with a pipe cleaner.
The coffee comes out slowly.	The coffee is grind too finely.	Use a different coffee blend or adjust the grinder.
	The brew group is dirty.	Clean the brew group.
	The coffee exit duct is blocked.	Clean the coffee exit duct with the handle of the multifunctional tool or a spoon handle.
	The machine circuit is blocked by limescale.	Descale the machine.
The frothed milk is too cold.	The cups are cold.	Preheat the cups by rinsing them with hot water.
The milk does not froth.	The classic milk frother is dirty or not assembled correctly.	Clean the classic milk frother and make sure it is correctly assembled.

Problem	Cause	Solution
	The type of milk used is not suitable for frothing.	Different types of milk result in different amounts of froth and different froth qualities. We have tested the following milk types which proved to deliver a good milk froth result: semi-skimmed or full-fat cow's milk, soy milk and lactose-free milk. Other types of milk have not been tested and may result in a small amount of milk froth.
There is water under the machine.	The drip tray is too full and overflowed.	Empty the drip tray when the 'drip tray full' indicator pops up through the drip tray. Always empty the drip tray before you start descaling the machine.
	The machine is not placed on a horizontal surface.	Place the machine on a horizontal surface so that the 'drip tray full' indicator works properly.
I cannot activate the AquaClean filter and the machine asks for descaling.	You have already replaced the AquaClean filter 8 times. After you have replaced the AquaClean filter 8 times, you need to descale the machine.	Descalce your machine first and install the AquaClean filter. Always activate the AquaClean filter in the menu. Also do this when you replace the filter.
	The filter has not been replaced in time after the AquaClean filter icon flashed and the capacity dropped to 0%.	Descalce your machine first and then install the AquaClean filter.
	You did not install the AquaClean filter during first installation, but after having brewed approx. 50 coffees (based on 100ml cups). The machine has to be completely limescale-free before you install the AquaClean filter.	First descalce the machine and then install a new AquaClean filter. After descaling, the filter counter is reset to 0/8. Always confirm filter activation in the machine menu. Also do this after filter replacement.
	You did not activate the new or replaced AquaClean filter in the machine menu. Also after replacing the filter, you need to confirm activation in the machine menu.	Descalce your machine first. Then activate the AquaClean filter in the menu. Also do this when you replace the filter.
The AquaClean filter icon does not appear on the display after I replaced the filter.	You did not confirm activation in the machine menu.	Confirm the activation of the filter in the machine menu. If the display shows 'START CALC CLEAN', you first need to descalce the machine. Remove the AquaClean filter before descaling and reinsert it afterwards.

Problem	Cause	Solution
The AquaClean filter is installed, but the descaling message appears.	You have not activated the AquaClean filter in the machine menu.	First descale the machine and then install a new AquaClean filter. This will reset the filter counter to 0/8. Always confirm filter activation in the machine menu, also after filter replacement.
The AquaClean filter does not fit.	You need to remove air from the filter.	Let air bubbles come out of the filter.
	There is still water in the water tank.	Empty the water tank before you install the filter.
	You are trying to install another filter than the AquaClean filter.	Only the AquaClean filter fits into the machine.
	The rubber o-ring is not attached to the AquaClean filter.	Check the packaging for the o-ring and attach it to the AquaClean filter.

Demo mode function

The machine is equipped with a demo mode function.

- 1 Press and hold the standby button for more than 8 seconds to enter the demo mode function.
- 2 To exit the demo mode, turn the machine OFF and ON using the main switch at the back of the machine.

Ordering accessories Saeco

To clean and descale the machine, only use the Saeco maintenance products. These products can be purchased in the Philips online shop (if available in your country) at www.shop.philips.com/service, from your local reseller or from the authorized service centers.

Ordering maintenance products:

Typenumber	Product
CA6700	Descaling solution
CA6903	AquaClean filter
HD5061	Brew group grease
CA6704	Degreasing tablets

Technical specifications

The manufacturer reserves the right to improve the technical specifications of the product. All the preset quantities are approximate.

30 English

Description	Value
Housing material	Thermoplastic
Size (w x h x d)	8.7 x 13.4 x 16.9 in.
Weight	265 oz
Power cord length	31.5 - 47.2 in.
Control panel	Front
Cup size	up to 6 in.
Water tank	60 fl oz, removable
Coffee bean hopper capacity	8.8 oz
Coffee grounds drawer capacity	15 pucks
Pump pressure	15 bar
Boiler	stainless steel boiler
Safety devices	thermal fuse
Energy saving mode	< 1 Wh
Nominal voltage - Power rating - Power supply	See data on inside of maintenance door

Disposal

This product may contain lead and mercury. Disposal of these materials may be regulated due to environmental considerations. For disposal or recycling information, please contact your local authorities or visit www.recycle.philips.com.

Warranty and support

If you need information or support, please visit www.saeco.com/support or read the separate international warranty leaflet.

To buy spare parts, visit www.shop.philips.com/service or go to your Saeco dealer or authorized service center. You can also contact the Philips/Saeco hotline in your country.

內容

簡介	32
重要事項	32
警告	33
電磁波 (EMF)	33
咖啡機概觀	33
使用者介面	34
首次安裝	34
手動沖洗循環	36
沖洗熱水管路	36
沖洗咖啡沖煮管路	36
Intenza+ 濾網	37
安裝 Intenza+ 濾網	37
更換 Intenza+ 濾網	38
測試水質硬度	38
設定水質硬度	39
飲品類型與份量	39
沖煮咖啡	40
調整咖啡流出口	40
以咖啡豆沖煮咖啡	40
沖煮 1 杯咖啡	40
沖煮 2 杯咖啡	40
以預磨咖啡粉沖煮咖啡	40
製作奶泡	40
熱水	41
調整數量與口味	41
Saeco 調整系統	41
調整咖啡份量	41
調整咖啡濃度	42
調整研磨設定	42
維護與保養	43
清潔滴盤與咖啡粉槽	43
清潔水箱	43
清潔豆槽	43
清潔沖煮組件與咖啡出口輸送管	44
每週清潔沖煮組件	44
每月清潔沖煮組件	45
潤滑沖煮組件	46
清潔經典奶泡器	47
每天清潔經典奶泡器	47
每週清潔經典奶泡器和蒸氣棒	47
除垢程序	47
若除垢程序中斷該怎麼做	48
警示圖示與錯誤碼	48
錯誤碼的意義	50
疑難排解	50
示範模式功能	53

訂購 Saeco 配件	53
技術規格	54
處理方式	54
保固與支援	55

簡介

親愛的顧客，感謝您購買 Saeco Incanto 全自動義式濃縮咖啡機！

咖啡是天然產品，其風味特色可能依據其產地、調豆與烘焙方式而有所不同。本咖啡機搭載了自行調整系統，能夠從您最喜愛的咖啡豆中萃取出最佳風味。機器會在沖煮 10-20 杯咖啡後進行自我調整。

您可以在本使用手冊中找到所需的資訊，並以最佳方式安裝、使用、維護並善用咖啡機。為充分享受

Saeco 為您提供的好處，請至下列位址註冊產品：www.saeco.com/welcome。

重要事項

咖啡機備有多種安全功能，但是您仍需仔細閱讀並遵照安全性指示，僅可根據相關指示使用咖啡機，以避免不當使用咖啡機所造成的意外傷害或毀壞。請保留本使用手冊以供日後參考。

- 連接的牆上插座務必符合咖啡機技術規格的電壓。
- 將咖啡機連接到有接地的電源插座。
- 請勿讓電源線懸掛在餐桌或流理台邊緣，或是接觸高溫表面。
- 請勿將咖啡機、插頭或電源線浸入水中 (有觸電的危險)。
- 請勿讓液體淋濕電源線接頭。
- 請勿將熱水噴嘴朝向身體部位：有燙傷的危險。
- 請勿接觸高溫表面，務必使用握把和旋鈕。
- 使用咖啡機背後的主開關，關閉咖啡機電源，並將電源插頭從插座上拔除：
 - 若發生故障。
 - 若長時間不用咖啡機。
 - 清潔咖啡機之前。
- 請拔插頭，切勿拉扯電源線。
- 接觸插頭時，請確保雙手乾燥。
- 當插頭、電源線或機器本身受損時，請停止使用。
- 請勿擅自改裝咖啡機或電源線。
- 務必讓飛利浦授權的維修中心進行維修作業，以免發生危險。
- 八歲以下的兒童切勿使用咖啡機。
- 在有人從旁監督或適當指示如何安全使用咖啡機，以及瞭解潛在危險的狀況下，咖啡機可供 8 歲以上兒童、身體官能或心智能力退化者，或是經驗與使用知識缺乏者使用。
- 除非兒童年滿 8 歲以上且有人監督，否則請勿讓兒童進行清潔和使用者維護。
- 請將咖啡機和電源線放在 8 歲以下兒童無法取得之處。
- 請看管孩童，避免他們將咖啡機當成玩具。
- 請勿將手指或其他物品插入咖啡研磨機。

警告

- 本咖啡機僅供一般家用，並非用於商店的員工廚房、辦公室、農舍或其他工作場所。
- 務必將產品置於穩固的平面上。搬運時也請保持直立狀態。
- 請勿將咖啡機放在加熱盤上，或直接放在高溫烤箱、加熱器或類似熱源旁邊。
- 豆槽只能放入烘焙的咖啡豆。如果豆槽放入研磨咖啡粉、即溶咖啡、未烘焙的咖啡豆或其他任何物質，可能會造成機器損壞。
- 安裝或拆除任何零件前，請務必先讓咖啡機冷卻。加熱面在使用後可能有餘熱。
- 請勿在水箱中裝入溫水、熱水或氣泡礦泉水，否則可能會損害水箱和咖啡機。
- 絕對不可使用鋼絲絨、磨蝕性的清潔劑或侵蝕性的液體 (例如汽油或丙酮) 清潔咖啡機。使用軟布沾水擦拭即可。
- 定期為咖啡機除垢。咖啡機會提示除垢的時間。如果未定期除垢，咖啡機可能會無法正常運作。保固並未涵蓋此情況的修復作業。
- 請勿將咖啡機放在低於 0° C 的地方。加熱系統內殘留的水可能會凍結並造成損壞。
- 若長時間不使用咖啡機，則請勿將水留在水箱內。水可能有汙染，每次使用咖啡機時均請使用乾淨的水。

電磁波 (EMF)

本飛利浦產品符合所有電磁波暴露的相關適用標準和法規。

咖啡機概觀

- 1 使用者介面
- 2 ESPRESSO 按鈕
- 3 ESPRESSO LUNGO 按鈕
- 4 AROMA STRENGTH 按鈕
- 5 待機按鈕
- 6 MENU 按鈕
- 7 熱水按鈕
- 8 STEAM 按鈕
- 9 經典奶泡器
- 10 可調式咖啡流出口
- 11 水箱蓋
- 12 豆槽蓋
- 13 預磨咖啡粉槽蓋
- 14 主開關
- 15 電線插座
- 16 維修門蓋
- 17 滴盤
- 18 滴盤釋放鈕
- 19 滴盤已滿指示燈
- 20 研磨調整旋鈕
- 21 水箱
- 22 沖煮組件
- 23 維修門內側標有清潔說明
- 24 咖啡出口輸送管
- 25 咖啡殘渣抽屜
- 26 咖啡粉槽
- 27 滴盤蓋

- 28 電線
- 29 清潔刷
- 30 潤滑膏
- 31 水質硬度試紙
- 32 多功能工具 (measuring scoop, grinder adjustment key and coffee duct cleaning tool)

使用者介面



使用這些按鈕瀏覽功能表：

ESPRESSO 按鈕 = ESC 按鈕：按下此按鈕可回到主選單。



AROMA STRENGTH 按鈕 = OK 按鈕：按下此按鈕可選擇、確認或停止功能。



STEAM 按鈕 = UP 按鈕：按下此按鈕可向上捲動顯示功能表。



MENU 按鈕 = DOWN 按鈕：按下此按鈕可向下捲動顯示功能表。

首次安裝

本機器經過咖啡沖泡測試。雖然機器經過仔細清潔，機器內可能留有咖啡殘渣。但是我們保證此咖啡機為全新機器。就如同大部分的全自動機器，您必須先沖煮若干杯咖啡後，讓機器完成自行調整，以便沖泡出最美味的咖啡。

- 1 移除咖啡機的所有包裝材料。
- 2 將咖啡機放置於餐桌或流理台，遠離水龍頭、水槽與熱源。

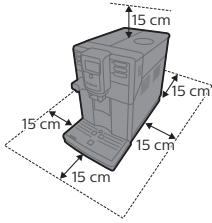

注意：咖啡機的上方、背面及兩側必須至少保留 15 公分的間隔距離。

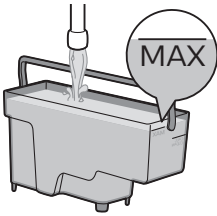

3 將清水注入水箱至 MAX 水位刻度。

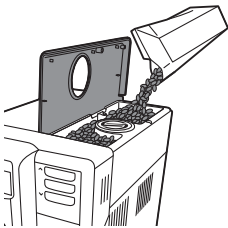

4 打開豆槽蓋。將咖啡豆倒入豆槽內，關上蓋子。

注意：請勿在豆槽中加入過量的咖啡豆，以免研磨器受損。

警告：僅能使用義式濃縮咖啡豆。請勿使用研磨咖啡粉、未烘焙或焦糖化的咖啡豆，否則可能造成機器損壞。

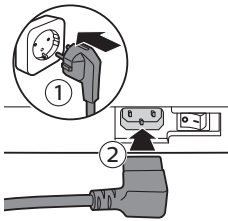

5 將電源插頭插入牆上插座 (1)，然後將小插頭插入機器後方的插座 (2)。

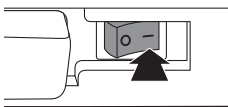

6 將主開關設定到 ON 位置，啟動咖啡機。
待機按鈕會閃爍。

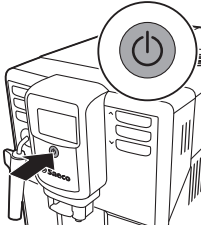

7 按下待機按鈕，開啟咖啡機電源。



- 顯示螢幕顯示管路預備圖示，表示您需要預備管路。

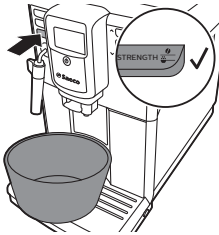

8 將一個容器放置在經典奶泡機下方。按下 OK 按鈕來啟動水流管路預備循環。

- 咖啡機開始流出熱水。
- 顯示螢幕顯示預備圖示。進度列會顯示預備循環的進展。

9 咖啡機進行加熱，顯示螢幕顯示溫度圖示。

10 將容器清空，並將其放回咖啡流出口下方。



11 咖啡機開始讓沖洗用水流過咖啡流出口。顯示螢幕顯示沖洗圖示與進度列。

注意：請勿打斷沖洗循環。

這時就可以開始使用機器。

手動沖洗循環

在手動沖洗循環期間，清水會流過水流與咖啡沖煮管路。這會持續數分鐘。

沖洗熱水管路

1 將一個容器放置在經典奶泡機下方。

2 按下 HOT WATER (熱水) 按鈕。

- 咖啡機開始流出熱水。

注意：若要中斷沖洗循環，按下 OK 按鈕即可。

3 機器流出 2 杯熱水 (0.5 公升) 後，請按下 OK 按鈕以停止熱水出水。重複步驟 1 至 3 兩次。

沖洗咖啡沖煮管路

1 將一個容器放在咖啡流出口下方。

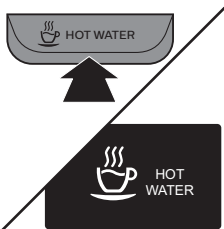

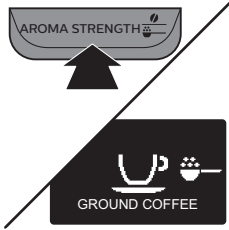

2 按下 AROMA STRENGTH 按鈕，選擇預磨咖啡粉沖煮功能。

注意：請勿將預磨咖啡粉加至預磨咖啡粉槽中。

3 按下 ESPRESSO LUNGO 按鈕。

- 咖啡機會從咖啡流出口開始流出水。

4 靜候片刻，直到咖啡機停止流出水，再清空容器。

5 重複步驟 1 至 4 兩次。

6 咖啡機回到主選單後，清空容器。您現在可以開始使用咖啡機。

Intenza+ 濾網

建議安裝 Intenza+ 濾網來減少咖啡機中的水垢沈積物，並提供過濾水，以完整保留每一杯咖啡的香氣與美味。

安裝 Intenza+ 濾網

注意：請務必依照下述方法，在咖啡機功能表中確認 Intenza+ 濾網的啟動。藉由在咖啡機功能表中啟動 Intenza+ 濾網，咖啡機會顯示濾網何時該更換。

1 從水箱中取出小型白色濾網，並收納在乾燥的地方。

注意：請留著小型白色濾網以供日後使用。在進行除垢程序時會用到。

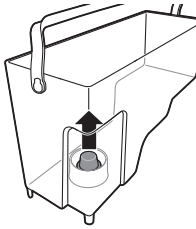

2 從包裝中取出濾網，並將開口朝上浸泡於冷水中。輕按濾網兩側，將氣泡洩出。

3 將濾網旋鈕旋轉至與您居住區域水質硬度相符的設定。

- a 水質很軟/軟水
- b 硬水 (預設)
- c 水質硬度很高

注意：您可以使用水質硬度試紙測試水質硬度。

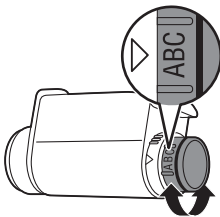

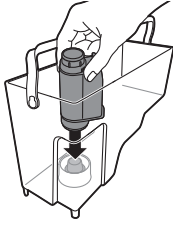

- 4 將濾網放入空的水箱中。將濾網往下壓，直到無法再移動為止。
- 5 在水箱中裝入乾淨的水到 MAX 刻度，然後將水箱裝回機器上。
- 6 按下 MENU 按鈕，並捲動至 INTENZA+ FILTER (INTENZA+ FILTER 濾網)。按下 OK 按鈕來確認。



- 7 選擇顯示幕上的 ON (開啟)，按下 OK 按鈕確認啟動。
- 8 讓熱水流 2 杯 (0.5 公升) 的量以完成啟動。請將這些水倒掉。

更換 Intenza+ 濾網



注意：當顯示幕上出現濾網圖示時，請盡快更換 Intenza+ 濾網。

- 1 取出濾網，更換為新的 Intenza+ 濾網。請遵循濾網的使用準備說明 (見 'Intenza+ 濾網')。
- 2 按下 MENU 按鈕，並捲動至 INTENZA+ FILTER (INTENZA+ FILTER 濾網)。按下 OK 按鈕來確認。
- 3 選擇顯示幕上的 RESET (重設)，按下 OK 按鈕確認重新啟動。
- 4 讓熱水流 2 杯 (0.5 公升) 的量以完成新濾網的啟動。請將這些水倒掉。



測試水質硬度

為了讓咖啡機能依據您所在地區的水質調整，請使用隨附的水質硬度試紙測試水質硬度。

- 1 將隨附的水質硬度試紙在自來水中浸泡 1 秒。
- 2 移開水質硬度試紙，等候 1 分鐘。



- 3 檢查有幾個方塊變成紅色，並對照下方的水質硬度表。

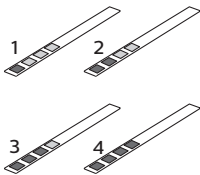

紅色方塊數	設定的值	水質硬度
1	1	水質很軟
2	2	軟水
3	3	硬水
4	4	水質硬度很高

設定水質硬度

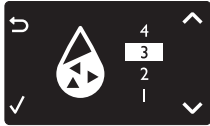

設定水質硬度

- 1 若要設定水質硬度，請按下 MENU 按鈕，選擇功能表，捲動並選擇 WATER HARDNESS。
- 2 按下 OK 按鈕，選擇在您當地的水質硬度。
- 3 按下 OK 按鈕來確認。
- 4 按下 ESC 按鈕可回到主選單。

飲品類型與份量

飲品名稱	說明	選擇方式
義式濃縮咖啡	泡沫層厚的小杯咖啡	控制面板上的按鈕
淡式義式濃縮咖啡	泡沫層厚的中杯大份量義式濃縮咖啡	控制面板上的按鈕
熱水		控制面板上的按鈕

飲品名稱	標準份量	份量範圍
義式濃縮咖啡	40 毫升	20 - 230 毫升
淡式義式濃縮咖啡	120 毫升	20 - 230 毫升

沖煮咖啡

調整咖啡流出口

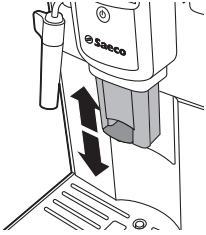

本咖啡機可用來沖煮不同種類的咖啡，容器可以是不同尺寸的杯子或玻璃杯。若要調整咖啡流出口的高度至杯子或玻璃杯尺寸適合的位置，請向上或向下滑動流出口。

以咖啡豆沖煮咖啡

沖煮 1 杯咖啡

- 1 將一個咖啡杯放在咖啡流出口下方。
- 2 按下 ESPRESSO 或 ESPRESSO LUNGO 按鈕，沖煮所選的咖啡。
 - 咖啡開始從咖啡流出口流出。

注意：若您想在機器流出預設的咖啡量前停止沖煮流程，請按下 OK 按鈕。

沖煮 2 杯咖啡

- 1 將兩個咖啡杯放在咖啡流出口下方。
- 2 您可以同時沖煮兩杯義式濃縮咖啡或淡式義式濃縮咖啡。按下您想要飲品的按鈕兩次。機器便會自動依序執行兩次研磨循環。

以預磨咖啡粉沖煮咖啡

當您使用預磨咖啡粉沖煮咖啡時，請使用隨附多功能工具中的量匙，將正確的咖啡粉量放入預磨咖啡粉槽中。若您加入過多的預磨咖啡粉，多餘的咖啡粉將會跑到咖啡粉抽屜中。

- 1 打開預磨咖啡粉槽蓋。
- 2 倒入一量匙的預磨咖啡粉至咖啡粉槽中。

警告：請勿在預磨咖啡粉槽中放入預磨咖啡粉以外的其他任何物質，因為可能會損壞機器。

- 3 關上預磨咖啡粉槽蓋。
- 4 將一個咖啡杯放在咖啡流出口下方。
- 5 按下 AROMA STRENGTH 按鈕，選擇預磨咖啡粉
 - 咖啡機將開始自動沖煮所選的飲品。

注意：使用預磨咖啡粉的話，一次只能沖煮一杯咖啡飲品。

製作奶泡

警告：小心燙傷！咖啡流出之前可能會先稍微噴出熱水。務必使用適當的保護握把。

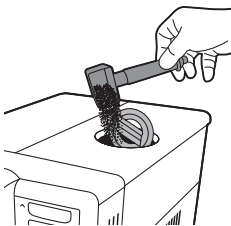

注意：使用蛋白質含量至少 3% 的冰牛奶 (溫度約 5° C/41° F)，確保製作出最佳奶泡。您可以使用全脂或半脫脂牛奶。也可以使用脫脂牛奶、豆漿或零乳糖牛奶。

注意：建議在使用前先沖洗水流管路。按下 STEAM (蒸氣) 按鈕以提供蒸氣數秒鐘。

- 1 將冰牛奶裝入壺中 1/3 容量處。
- 2 將經典奶泡器浸入牛奶中。按下 STEAM (蒸氣) 按鈕。

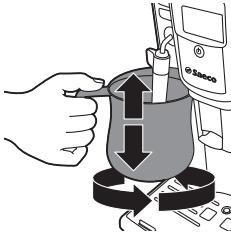
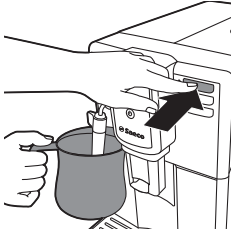

- 3 將壺輕輕旋轉並上下移動，即可將牛奶打成奶泡。
- 4 按下 OK 按鈕，即可停止製作奶泡。

熱水

警告：小心燙傷！咖啡流出之前可能會先稍微噴出熱水。務必使用適當的保護握把。

- 1 將咖啡壺放在經典奶泡器下方。
- 2 按下 HOT WATER (熱水) 按鈕。開始自動流出熱水。
- 3 按下 OK 按鈕，即可停止熱水流出。

調整數量與口味

Saeco 調整系統

咖啡是天然產品，其風味特色可能依據其產地、調豆與烘焙方式而有所不同。本咖啡機搭載了自行調整系統，能夠從您最喜愛的咖啡豆中萃取出最佳風味。機器會在沖煮若干杯咖啡後進行自我調整。

調整咖啡份量

您可以依據您的口味和杯子的大小，調整沖煮的飲品份量。



- 1 如欲調整義式濃縮咖啡的份量，按住 ESPRESSO 按鈕，直到顯示螢幕顯示 MEMO (記憶) 圖示。
 - 咖啡機進入程序設定階段，開始沖煮所選的飲品。

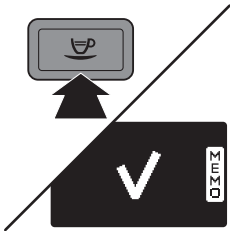

- 2 當杯子裝滿需要的義式濃縮咖啡量時，按下 OK 按鈕。
 - 顯示螢幕上的打勾圖示顯示該按鈕已經設定好：每次按下該按鈕，咖啡機將沖煮設定好的義式濃縮咖啡量。若要設定淡式義式濃縮咖啡的份量，請遵循同樣的程序：按住該飲品的按鈕，並在杯中已注入想要的咖啡量時按下 OK 按鈕。

調整咖啡濃度

若要變更咖啡份量，按下 AROMA STRENGTH 按鈕。您每次按下 AROMA STRENGTH 按鈕，香氣強度都會變更一度。顯示螢幕顯示選擇的強度，並只會在沖煮咖啡時儲存此設定。

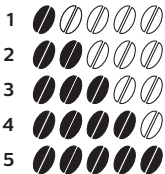

- 1 非常溫和
- 2 溫和
- 3 一般
- 4 濃
- 5 非常濃

注意：咖啡機會針對每種咖啡強度，自動注入正確的咖啡量。

GROUND COFFEE (研磨咖啡) 是咖啡強度功能表中的最後一個選項。選擇此選項就可用研磨咖啡粉沖煮咖啡。使用隨附多功能工具中的量匙，量出正確的研磨咖啡粉量。

注意：咖啡機在沖煮咖啡時，將回到主畫面，並儲存選擇的香氣強度。

調整研磨設定

您可以使用多功能工具握把中的研磨器調整鑰匙，調整研磨器設定。根據每次選定的研磨設定，陶瓷咖啡研磨器可確保您沖煮的每杯咖啡都完美地經過均勻的研磨。如此可保留完整的咖啡香氣，並為每杯咖啡帶來完美口感。

- 1 打開豆槽蓋。

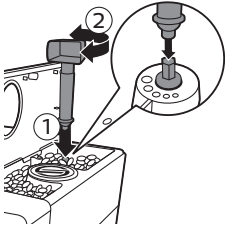

- 2 將研磨器調整鑰匙放在研磨調整旋鈕上 (1)。往下推並往左或往右旋轉 (2)，每次轉動一個溝槽。
- 您共有 5 種不同的研磨設定可以選擇。點愈小，咖啡愈濃。

注意：轉動研磨調整旋鈕時，每次請勿超過一個溝槽，以免研磨器受損。

注意：使用新設定時，沖煮 2-3 杯咖啡之後，差異會變得更明顯。

維護與保養

咖啡機的維護極為重要，如此才能延長咖啡機的使用壽命，並確保沖煮出最佳品質與口感的咖啡。

清潔滴盤與咖啡粉槽

在咖啡機為開機狀態時執行下列動作：

- 當顯示螢幕顯示「清空咖啡粉槽」圖示時，清空咖啡粉槽。
- 滴盤已滿指示燈透過滴盤亮起時，代表滴盤已滿。每天清空並清潔滴盤。

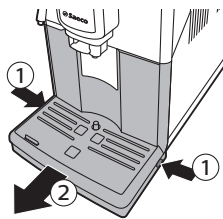
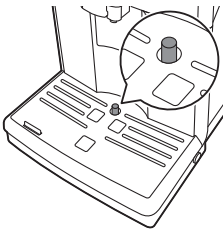

- 1 向左轉動經典奶泡器。
- 2 按下滴盤兩側的釋放按鈕 (1)，將滴盤拉出咖啡機 (2)。
- 3 移除並清空咖啡粉槽。
- 4 清空滴盤後，放在水龍頭下沖洗。
- 5 請重新將咖啡粉槽裝回滴盤。
- 6 將滴盤滑入咖啡機內，直到聽見「喀噠」一聲卡入定位為止。

注意：當您移除滴盤時，請確定咖啡機仍維持在開機狀態。若在移除滴盤前將咖啡機關機，重新開啟咖啡機後，即便滴盤已空，「清空咖啡粉槽」圖示仍會出現在顯示螢幕上。

清潔水箱

- 1 定期將水箱從咖啡機移除，並以清水沖洗。
- 2 將清水注入水箱至 MAX 刻度，然後將水箱裝回咖啡機上。

清潔豆槽

每個月用乾布清潔豆槽一次。

清潔沖煮組件與咖啡出口輸送管

每週清潔沖煮組件

- 1 關閉咖啡機電源，並拔除插頭。
- 2 連同咖啡粉槽一起移除滴盤。
- 3 清空滴盤後，放在水龍頭下沖洗。
- 4 清空咖啡粉槽，並在水龍頭下以溫水沖洗。
- 5 打開維修門蓋。
- 6 按下 PUSH 按鈕 (1) 並拉動沖煮組件上的握柄，將其從咖啡機取下 (2)。

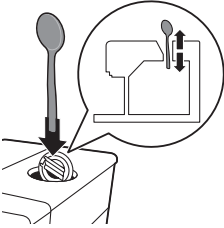
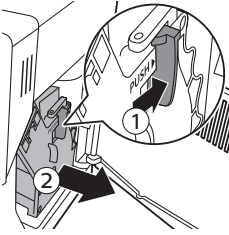

- 7 以湯匙握把徹底清潔咖啡出口輸送管頂部。如圖所示插入。

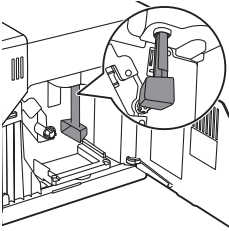

- 8 使用湯匙握把或隨附的多功能工具，徹底清潔咖啡出口輸送管底部。如圖所示插入。

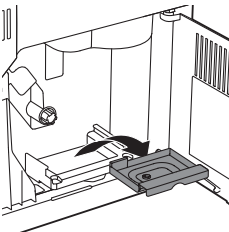

- 9 移除並清空咖啡粉殘渣槽後，在水龍頭下以溫水沖洗。晾乾後重新插入。

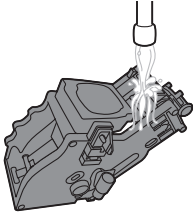

10 在水龍頭下以溫水徹底沖洗沖煮組件。請仔細清潔上方濾網。

注意事項： 請勿將沖煮組件放入洗碗機清洗，同時也請勿使用洗碗精或清潔劑來清潔。這可能會造成沖煮組件故障，並影響咖啡的口感。

11 請徹底風乾沖煮組件。

注意： 請勿用布擦乾沖煮組件，以避免沖煮組件內累積纖維。

12 以沾濕的軟布清潔咖啡機內部。

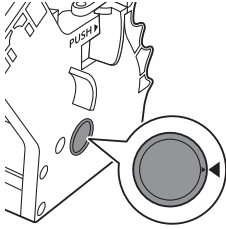

13 將沖煮組件推回咖啡機之前，請確定兩側的參考記號相符。如不相符，請執行下列步驟：

- 確定拉桿接觸到沖煮組件底部。

14 請確定沖煮組件的鎖定鉤位於正確的位置。

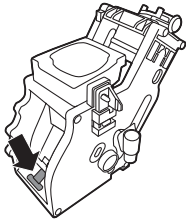

- 要將鉤正確定位，請將它往上推到最上方的位置。

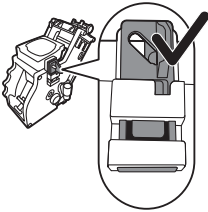

- 如果鉤還在最底部的位置，它就無法正確定位。

15 沿著兩側的導引軌道將沖煮組件推回咖啡機，直到聽見「喀噠」一聲卡入定位為止。

警告： 請勿按下 PUSH 按鈕。

16 關閉維修門蓋。

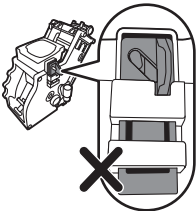

每月清潔沖煮組件

- 請在咖啡機沖煮 500 杯咖啡後執行此清潔循環，或每個月執行一次此清潔循環。
- 請使用去油汗錠執行此清潔循環。

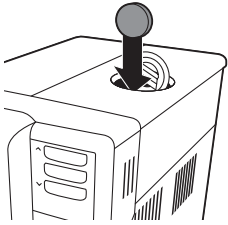

警告：去油汙錠只可用於清潔。去油汙錠並不具有除垢功能。

- 1 將一個容器放在咖啡流出口下方。
- 2 按下 AROMA STRENGTH 按鈕，選擇預磨咖啡粉。
- 3 將去油汙錠放入研磨咖啡粉槽中。
- 4 按下 ESPRESSO LUNGO 按鈕。咖啡機會從咖啡流出口流出水。
- 5 進度列達到中間時，將咖啡機背後的主開關切至 OFF。
- 6 靜置約 15 分鐘的時間，讓去油汙溶液產生作用。
- 7 將主開關設定至 ON。
- 8 按一下待機按鈕。
- 9 靜候片刻，直到咖啡機執行自動沖洗循環。
- 10 執行「每週清潔沖煮組件」程序。
- 11 連同咖啡粉槽一起移除滴盤。清空滴盤與咖啡粉槽後，再裝回咖啡機。
- 12 按下 AROMA STRENGTH 按鈕，選擇預磨咖啡粉。
- 13 按下 ESPRESSO LUNGO 按鈕。咖啡機會從咖啡流出口流出水。
- 14 重複步驟 12 與 13 兩次。倒掉流出的水。
- 15 如欲清潔滴盤，請在滴盤中放入去油汙錠，並在滴盤中注入達三分之二容量的熱水。靜置約 30 分鐘，讓去油汙錠產生作用。接著倒空滴盤並徹底沖洗。

潤滑沖煮組件

為發揮咖啡機的最大效能，請務必為沖煮組件進行潤滑。請參考下表的潤滑頻率。如需支援，請造訪我們的網站：www.philips.com/support。

使用類型	每日產品用量	潤滑頻率
低度	1-5	每 4 個月
一般	6-10	每 2 個月
重度	>10	每月

- 1 關閉咖啡機電源，並拔除插頭。
- 2 拆卸沖煮組件，然後按照「每週清潔沖煮組件」一節中的指示，在水龍頭下以溫水徹底沖洗。
- 3 在沖煮組件底部的軸周圍塗抹一層薄薄的潤滑劑。

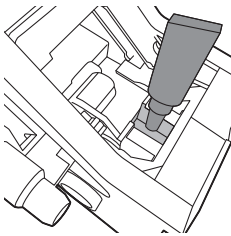

- 4 在軌道兩側塗抹一層薄薄的潤滑劑 (見圖示)。
- 5 按照「每週清潔沖煮組件」一節的指示裝入沖煮組件。

潤滑劑管可重複使用。

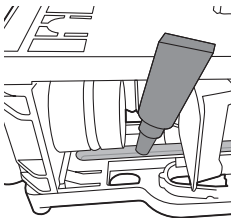

清潔經典奶泡器

每天清潔經典奶泡器

取下經典奶泡器外部零件，並以清水沖洗。

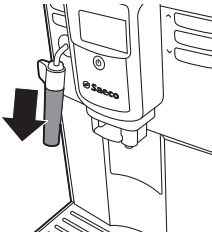

每週清潔經典奶泡器和蒸氣棒

1 取下經典奶泡器外部零件，並以清水沖洗。

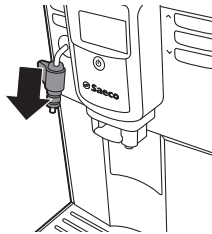

2 從蒸氣棒取下經典奶泡器上部零件，並以清水沖洗。

3 請用濕布清潔蒸氣棒。

4 重新組裝所有的經典奶泡器零件。

除垢程序

當顯示幕顯示「START CALC CLEAN (開始除鈣清洗)」，就必須為機器除垢。若顯示幕出現此訊息時，沒有為機器除垢，咖啡機可能會無法正常運作。若是這樣，保固將不涵蓋此種維修。

僅能使用 Saeco 除垢溶液來為機器除垢。Saeco 除垢溶液專為確保讓咖啡機發揮最佳效能而設計。使用其他除垢產品可能會損壞咖啡機，並在水中留下殘留物。您可以前往 www.shop.philips.com/service，在線上商店購買 Saeco 除垢溶液。除垢程序會持續 30 分鐘，其中包含除垢循環和沖洗循環。您可以隨時按下 ESC 按鈕暫停除垢或沖洗循環。若要繼續除垢或沖洗循環，按下 OK 按鈕即可。

注意：請勿在除垢程序期間取下沖煮組件。**警告：**除垢程序進行時，請勿飲用除垢溶液或流出的水。

1 取下的滴盤與咖啡粉槽後，清空並清潔之後再裝回原位。

2 取下經典奶泡器外部零件。

3 在咖啡流出口和經典奶泡器下方放置大型容器 (1.5 公升)。

4 顯示幕顯示「START CALC CLEAN (開始除鈣清洗)」時，按下 OK 按鈕，開始進行除垢程序。如有安裝熱水流出口，請將它取下。



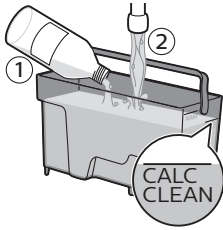

- 顯示幕上的下列圖示會提醒您取下 Intenza+ 濾網。

注意：您可以按下 ESC 按鈕跳過除垢。若您想要稍後開始除垢程序，請按下 MENU 按鈕，選擇 MENU (功能表)，捲動並選擇 DESCALING (除垢)。按下 OK 以確認。

- 取出水箱。若有使用 Intenza+ 濾網的話，請將濾網從水箱取出，更換為最初的白色小濾網。
- 將除垢溶液倒入水箱中。將清水注入水箱至 CALC CLEAN 刻度。將水箱推回咖啡機中。按下 OK 按鈕來確認。
 - 除垢程序的第一階段開始。咖啡機開始每隔一段時間注入除垢溶液。
 - 顯示螢幕顯示除垢圖示、階段指示與持續時間。第一階段需要 20 分鐘。
- 讓咖啡機流出除垢溶液直到水箱已空。
- 取出水箱，並沖洗乾淨。
- 將清水注入水箱至 CALC CLEAN 刻度。將水箱推回咖啡機中，按下 OK。
- 移除並清空容器，再將其放回咖啡機出口下方。按下 OK 以確認。
- 除垢程序的第二階段開始，第二階段是沖洗循環。此階段需要 3 分鐘。顯示螢幕顯示沖洗圖示與此階段的持續時間。

注意：若水箱水位未達到 CALC CLEAN 刻度，咖啡機可能需要進行另一次沖洗循環。

- 等待咖啡機停止流出水。當顯示螢幕上出現打勾圖示，就代表除垢程序完成。
- 按下 OK 按鈕，退出除垢程序。咖啡機開始加熱，並執行自動沖洗循環。
- 移除並清空容器。
- 除垢後請清潔經典奶泡器。
- 執行「每週清潔沖煮組件」循環清潔沖煮組件。
- 重新安裝 Intenza+ 濾網。

若除垢程序中斷該怎麼做

一旦除垢程序開始後，您就必須讓機器完成程序，不得關閉機器電源。若機器在循環中遇到問題，您可以按下待機按鈕，退出除垢程序。若發生此情形，或出現電源中斷或電線不慎脫落的狀況，請執行下列步驟：

- 關閉咖啡機電源。
- 請倒光水箱內的水後，徹底洗淨水箱。
- 將水箱加水至 CALC CLEAN 刻度後，開啟咖啡機電源。
 - 咖啡機將加熱，並執行自動沖洗循環。
- 沖煮任何咖啡飲品前，請執行手動沖洗循環 (見 '手動沖洗循環')。

注意：若除垢程序尚未完成，需要儘快讓咖啡機執行另一次除垢程序。

警示圖示與錯誤碼



警示圖示以紅色顯示。下列是可能出現在顯示幕上的警示圖示清單，及其意義。

- 將清水注入水箱至 MAX 水位刻度。



- 豆槽已空。在豆槽內放入新的咖啡豆。



- 沖煮組件不在咖啡機中，或未正確插入。插入沖煮組件。

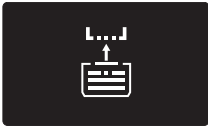

- 插入滴盤。



- 關閉維修門蓋。



- 移除咖啡粉槽並清空。



- 當顯示幕上出現濾網圖示時，必須更換 Intenza+ 濾網 (見 '更換 Intenza+ 濾網')。



- 若顯示幕顯示錯誤碼，請參閱「錯誤碼的意義」，了解顯示幕上錯誤碼的意義以及您可以怎麼做。顯示幕出現此圖示時無法使用咖啡機。

- 豆槽蓋為開啟狀態。關閉豆槽蓋。



錯誤碼的意義

錯誤碼	問題	原因	可能的解決方法
1	咖啡研磨器阻塞。	咖啡出口輸送管堵塞。	以多功能工具握把或湯匙握把徹底清潔咖啡出口輸送管。
3 - 4	沖煮組件有問題。	沖煮組件有髒汙。 沖煮組件安裝不正確。	徹底拆下沖煮組件。 請取出沖煮組件並重新裝入。將沖煮組件推回咖啡機之前，請確定兩側的參考記號相符。
5	水流管路有問題。	水流管路中有空氣。	將水箱拆下並裝回，並重複數次。請確認水箱是否已正確插入咖啡機。檢查水箱槽是否乾淨。
14	代表咖啡機已過熱。	這有幾種可能的原因。	關閉咖啡機電源，在 30 分鐘後重新開啟咖啡機電源。嘗試此方法 2 或 3 次。

若上述的解決方案無法協助您將顯示螢幕上的錯誤碼圖示消除，並讓咖啡機恢復正常運作，請聯絡飛利浦 Saeco 熱線。保證書或 www.saeco.com/support 上可找到詳細聯絡資料。

疑難排解

本單元概述了使用本機器最常遇到的問題。如果無法利用以下資訊解決遇到的問題，請造訪 www.saeco.com/support 瀏覽常見問題清單，或聯絡您所在國家/地區的飛利浦客戶服務中心。

問題	原因	解決方法
咖啡機無法開啟。	咖啡機未連接電源，或主開關設置為 OFF 位置。	檢查主電源線是否正確插入。 請確定主開關設置於 ON 位置。
咖啡機處於 DEMO (示範) 模式。	按壓待機按鈕超過 8 秒。	使用咖啡機背後的主開關，關閉咖啡機電源後再重新開啟。

問題	原因	解決方法
滴盤一下就滿了。	這是正常現象。咖啡機會用水清洗內部管路和沖煮組件。部分的水會經由內部系統直接流入滴盤。	「滴盤已滿」指示燈透過滴盤蓋亮起時，請將滴盤清空。 在流出口下方放一個杯子，來收集清洗後的水。
「咖啡粉槽已滿」圖示持續顯示。	您在咖啡機關閉時清空咖啡粉槽。	請一定要在咖啡機電源開啟時清空咖啡粉槽。如果您在咖啡機關閉時清空咖啡粉槽，表示咖啡循環計數器並未重新設定。若是這樣，即使咖啡粉槽尚未裝滿，「清空咖啡粉槽」圖示將會持續出現在顯示螢幕上。
	您太快裝回咖啡粉槽。	請在顯示幕提示您將咖啡粉槽裝回咖啡機之後，再將咖啡粉槽裝回去。
我無法拆下沖煮組件。	沖煮組件的位置不正確。	關閉維修門蓋。關閉咖啡機電源後再開啟。靜候咖啡機出現就緒畫面，然後再拆除沖煮組件。清潔沖煮組件。
	您尚未拆除咖啡粉槽。	請先拆除咖啡粉槽後，再拆除沖煮組件。
我無法插入沖煮組件。	沖煮組件的位置不正確。	在裝回沖煮組件之前，您未將沖煮組件放置於原本的位置。確定拉桿接觸到沖煮組件的底部，同時也請確定沖煮組件的鉤位於正確的位置。 關閉咖啡機電源後再次開啟，藉此重新設定咖啡機。請重新裝回滴盤和咖啡粉槽，但不要裝回沖煮組件。關閉保養門蓋，開啟咖啡機電源後再關閉。然後嘗試將沖煮組件裝回。
	咖啡機仍在進行除垢程序。	除垢程序進行時，無法拆除沖煮組件。請先完成除垢程序，才能拆除沖煮組件。
咖啡奶泡太少或咖啡太淡。	研磨器設為過粗的顆粒設定。	將研磨器調為較細的設定。
	使用不適合的咖啡調豆。	請開始使用不同的咖啡調豆。
	咖啡機正在自行調整。	沖煮幾杯咖啡。
	沖煮組件有髒汙。	清潔沖煮組件。
咖啡從咖啡流出口漏出。	咖啡流出口堵塞。	以管路清潔劑清潔咖啡流出口及其洞口。
咖啡不夠燙。	您使用的杯子過冷。	先以熱水清洗來預熱杯子。
	溫度設定過低。檢查功能表設定。	在功能表中將溫度設定為「高」。
	您加了牛奶。	無論您加的牛奶是熱還是冷，多少都會降低咖啡的溫度。

問題	原因	解決方法
咖啡機會研磨咖啡豆，但是沒有流出咖啡。	咖啡出口輸送管堵塞。	以多功能工具握把或湯匙握把清潔咖啡出口輸送管。
	研磨設定過細。	將研磨器調為較粗的設定。
	沖煮組件有髒汙。	清潔沖煮組件。
	咖啡流出口有髒汙。	以管路清潔劑清潔咖啡流出口及其洞口。
咖啡流出的速度太慢。	研磨顆粒太細。	使用不同的咖啡調豆或調整研磨器。
	沖煮組件有髒汙。	清潔沖煮組件。
	咖啡出口輸送管堵塞。	以多功能工具握把或湯匙握把清潔咖啡出口輸送管。
	咖啡機管路被水垢阻塞。	為咖啡機除垢。
奶泡太冷。	杯子過冷。	先以熱水清洗來預熱杯子。
牛奶沒有奶泡。	經典奶泡器有髒汙，或組裝不正確。	清潔經典奶泡器，並確定已經正確組裝。
	所用的牛奶種類不適合製作奶泡。	牛奶種類會影響奶泡量和奶泡品質。我們已測試下列的牛奶種類，結果證明這些牛奶都能製作出優質奶泡：半脫脂牛奶或全脂牛奶、豆漿和零乳糖牛奶。其他種類的牛奶未經測試，奶泡量可能會較少。
咖啡機下方有積水。	滴盤過滿而溢出。	「滴盤已滿」指示燈透過滴盤亮起時，請將滴盤清空。進行咖啡機除垢之前，務必先清空滴盤。
	咖啡機未放在水平表面上。	將咖啡機置於水平表面上，以便「滴盤已滿」指示燈能夠正常運作。
我無法啟動 AquaClean 濾水器，咖啡機將要求進行除垢程序。	您已經更換 8 次 AquaClean 濾水器。在您更換 8 次 AquaClean 濾水器之後，您必須為咖啡機進行除垢。	先為咖啡機除垢，再安裝 AquaClean 濾水器。請一律在功能表中啟動 AquaClean 濾水器。當您更換濾芯時也必須這麼做。
	在 AquaClean 濾水器圖示快速閃爍且容量下降至 0% 之後，未及時更換濾水器。	先為咖啡機除垢，再安裝 AquaClean 濾水器。
	您未在首次安裝時安裝 AquaClean 濾水器，但已沖煮約 50 杯咖啡 (每杯 100 毫升)。在您安裝 AquaClean 濾水器前，咖啡機必須完全沒有水垢。	首先為咖啡機除垢，接著安裝新的 AquaClean 濾水器。除垢後，濾水器計數器將重設為 0/8。請一律在咖啡機功能表中確認濾水器啟動。當您更換濾芯之後也必須這麼做。

問題	原因	解決方法
	您沒有在咖啡機功能表中啟動新的或替換用 AquaClean 濾水器。在更換濾水器後，您必須在咖啡機功能表中確認啟動。	請先為咖啡機除垢。然後在功能表中啟動 AquaClean 濾水器。當您更換濾芯時也必須這麼做。
我更換濾水器之後，顯示幕上沒有出現 AquaClean 濾水器圖示。	您沒有在咖啡機功能表中確認啟動。	請在咖啡機功能表中確認濾水器啟動。如果顯示幕顯示「START CALC CLEAN (開始除鈣清洗)」，就必須先為咖啡機除垢。在進行除垢之前，請拆下 AquaClean 濾水器，除垢之後再將它重新插入。
AquaClean 濾水器已安裝，但出現除垢訊息。	您沒有在咖啡機功能表中啟動 AquaClean 濾水器。	首先為咖啡機除垢，接著安裝新的 AquaClean 濾水器。這會將濾水器計數器重設為 0/8。請一律在咖啡機功能表中確認濾水器啟動，同時也必須在濾水器更換後進行確認。
AquaClean 濾水器不符。	您必須移除濾水器內的空氣。	讓氣泡從濾水器中排出。
	水箱中仍有水。	在您安裝濾水器前，清空水箱。
	您嘗試安裝 AquaClean 濾水器之外的濾水器。	只有 AquaClean 濾水器會符合咖啡機需求。
	橡膠 O 型環未安裝至 AquaClean 濾水器。	檢查 O 型環的包裝，然後將它安裝至 AquaClean 濾水器。

示範模式功能

本咖啡機具備示範模式功能。

- 1 按住待機按鈕超過 8 秒，就能進入示範模式功能。
- 2 若要退出示範模式，使用咖啡機背後的主開關，關閉咖啡機電源後再開啟。

訂購 Saeco 配件

如欲清潔與除垢本機器，只能使用 Saeco 維護產品。您可以在飛利浦線上商店 (若您所在的國家/地區有提供服務的話) www.shop.philips.com/service、本地經銷商或授權服務中心購買這些產品。

訂購保養產品：

型號	產品
CA6700	除垢溶液
CA6702	Intenza+
HD5061	沖煮組件潤滑劑
CA6704	去油汙錠

技術規格

製造商保有更新此產品技術規格的權利。所有預設的數量皆為約略值。

說明	值
外殼材質	熱塑性塑膠
尺寸 (寬 x 高 x 深)	8.7 x 13.4 x 16.9 英寸
體重	265 盎司
電線長度	31.5 - 47.2 英寸
控制面板	正面
杯子大小	最長 6 英寸
水箱	60 液體盎司，可拆除
咖啡豆槽容量	8.8 盎司
咖啡粉抽屜容量	15 包
幫浦水壓	15 巴
鍋爐	不鏽鋼鍋爐
安全裝置	防過熱保險絲
省電模式	< 1 瓦時
額定電壓 - 功率定額 - 電力供應	詳見保養門蓋內的資料

處理方式

此產品可能含有鉛與汞。由於環境考量，這些材質的處理方式通常受到條例規範。如需處理方式或回收資訊，請洽當地相關單位或造訪 www.recycle.philips.com。

設備名稱：飛利浦SAECO INCANTO 全自動義式咖啡機 型號 (型式)：HD8911 Equipment name Type designation (Type)						
單元 Unit	限用物質及其化學符號 Restricted substances and its chemical symbols					
	鉛 Lead (Pb)	汞 Mercury (Hg)	鎘 Cadmium (Cd)	六價鉻 Hexavalent chromium (Cr (VI))	多溴聯苯 Polybrominated biphenyls (PBB)	多溴二苯醚 Polybrominated diphenyl ethers (PBDE)
印刷電路板	-	○	○	○	○	○
電源線組	-	○	○	○	○	○
分配電機螺絲	-	○	○	○	○	○
齒輪金屬棒	-	○	○	○	○	○
<p>備考1. “超出0.1 wt %”及“超出0.01 wt %”係指限用物質之百分比含量超出百分比含量基準值。 Note 1: “Exceeding 0.1 wt %” and “exceeding 0.01 wt %” indicate that the percentage content of the restricted substance exceeds the reference percentage value of presence condition.</p> <p>備考2. “○”係指該項限用物質之百分比含量未超出百分比含量基準值。 Note 2: “○” indicates that the percentage content of the restricted substance does not exceed the percentage of reference value of presence.</p> <p>備考3. “-”係指該項限用物質為排除項目。 Note 3: The “-” indicates that the restricted substance corresponds to the exemption.</p>						

保固與支援

如需資訊或支援，請造訪：www.saeco.com/support，或另行參閱全球保固說明書。

若要購買備用零件，請造訪 www.shop.philips.com/service，或洽詢您的 Saeco 經銷商或授權的服務中心。您也可以聯絡您所在國家的飛利浦/Saeco 服務專線。

4219.460.3747.2 (10/2017) rev.00



421946037472

www.saeco.com/care



>75% recycled paper
>75% papier recyclé