

# Operating Instructions

## Countertop Coffee Machine



To prevent accidents and machine damage, you absolutely **must** read these instructions before installation or use.

# Packaging material / Disposal of old machine

---

## Packaging material

The packing materials protect the appliance during shipping.

The original box and polystyrene pieces can be saved to transport the appliance in the future.

The original packaging should also be kept in case the appliance ever needs to be returned to Miele for servicing.

## Disposal of your old appliance

Electrical and electronic appliances contain valuable materials. They also contain certain substances, compounds and components which were essential for the proper functioning and safe use of the equipment. Handling these materials improperly by disposing of them in your household waste can be harmful to your health and the environment. Therefore, please do not dispose of your old appliance with regular household waste and follow local regulations on proper disposal.



Consult with local authorities, dealers or Miele in order to dispose of and recycle electrical and electronic appliances. Miele assumes no responsibility for deleting any personal data left on the appliance being disposed. Please ensure that your old appliance is kept away from children until removal. Observe safety requirements for appliances that may tip over or pose an entrapment hazard.

---

<b>Packaging material / Disposal of old machine</b> .....	2
<b>IMPORTANT SAFETY INSTRUCTIONS</b> .....	6
<b>Guide to the appliance</b> .....	16
<b>Controls and display</b> .....	17
<b>Accessories</b> .....	18
<b>Before using for the first time</b> .....	19
Before using for the first time .....	19
Turning on for the first time .....	19
Water hardness .....	20
<b>Operation</b> .....	22
<b>Filling the water tank</b> .....	23
<b>Filling the coffee bean container</b> .....	24
<b>Turning the machine On and Off</b> .....	25
<b>Cup heating</b> .....	26
<b>Adjusting the coffee dispensers to the cup height</b> .....	27
<b>Preparing beverages</b> .....	28
Making a coffee drink.....	28
Canceling preparation .....	29
Double portion.....	29
Coffee pot: Making several cups of coffee one after the other.....	30
Making coffee drinks from ground coffee .....	30
Preparing the hot water (CM 6350) .....	31
Preparing user profile drinks .....	32
<b>Making coffee with milk</b> .....	33
Milk flask .....	33
Using milk cartons or bottles .....	34
Preparing drinks with milk .....	34
<b>Grinder setting</b> .....	35
<b>Amount of coffee, brew temperature and pre-brewing</b> .....	36
Amount of coffee.....	36
Brewing temperature.....	36
Pre-brewing ground coffee.....	37

# Contents

---

<b>Portion size</b> .....	38
<b>User profiles</b> .....	40
Accessing a user profile .....	40
Creating a user profile .....	40
Selecting a user profile.....	41
Changing the name .....	41
Deleting a user profile.....	41
Changing a user profile .....	41
<b>Settings</b> .....	42
Accessing the "Settings" menu.....	42
Changing and saving settings .....	42
Setting options .....	43
Language.....	45
Time of day.....	45
Timer .....	45
Eco mode .....	46
Lighting.....	46
Info (displaying information) .....	47
Locking the coffee system (System lock  ) .....	47
Water hardness .....	47
Display brightness .....	47
Volume.....	47
Cup heating .....	47
Factory default setting.....	48
Showroom program (Demo mode).....	48
<b>Cleaning and care</b> .....	49
Overview.....	49
Clean by hand or in dishwasher .....	50
Drip tray and grounds container.....	52
Drip tray cover .....	53
Water container .....	53
Stainless steel water intake valve filter.....	54
Main dispenser with cappuccinatore .....	54
Stainless steel milk flask .....	56
Milk pipework .....	56
Bean container and ground coffee chute .....	57
Housing .....	57
Care programs.....	58
Accessing the "Maintenance" menu .....	58
Rinsing the coffee system .....	58
Rinsing the milk pipework .....	59

Degreasing the brew unit and cleaning inside .....	60
<b>Descaling the machine</b> .....	64
<b>Frequently Asked Questions</b> .....	66
Messages in the display .....	66
Unusual performance of the coffee system .....	69
Unsatisfactory results.....	76
<b>Transport</b> .....	78
Evaporating the coffee system.....	78
Packaging.....	78
<b>Technical Service</b> .....	79
<b>Saving energy</b> .....	80
<b>Electrical connection</b> .....	81
<b>Installation</b> .....	82
<b>Appliance dimensions</b> .....	83
<b>Technical data</b> .....	85

## IMPORTANT SAFETY INSTRUCTIONS

---

Please read these instructions carefully to prevent accidents and appliance damage.

This appliance complies with current safety requirements. Improper use of the appliance can cause personal injury and material damage. Read this safety information carefully before operating the appliance.

They contain important information on the safe installation, operation, and care of your coffee system. To avoid the risk of personal injury or damage to the coffee system, it is important that you carefully read the instructions. Miele cannot be held liable for damage caused by non-compliance with these **IMPORTANT SAFETY INSTRUCTIONS**.

Keep these instructions in a safe place and pass them on to any future user.

# IMPORTANT SAFETY INSTRUCTIONS

---

## Intended use

- ▶ Use this coffee system only in standard household environments for making coffee beverages such as espresso, cappuccino, latte macchiato, etc. Any other type of use is not permitted.
- ▶ The coffee system is not suitable for outdoor use.
- ▶ The machine is intended only for the preparation of coffee-based drinks such as espresso, cappuccino, latte macchiato etc. Any other usage is not supported.
- ▶ Persons which lack physical, sensory or mental abilities or experience with the machine should not use it without supervision or instruction by a responsible person.

# IMPORTANT SAFETY INSTRUCTIONS

---

## Safety with children

 Caution! Danger of burning and scalding on the dispensing dispensers.

Children's skin is far more sensitive to high temperatures than that of adults.

Ensure children do not touch hot surfaces of the coffee system or place parts of their body under the dispensing dispensers.

- ▶ Keep the coffee system out of reach of children.
- ▶ Keep children away from the appliance, the power cord and outlet.
- ▶ Children should be supervised when they are near the coffee system. Do not allow them to play with it or to use the controls.
- ▶ Remember that coffee and espresso are not suitable drinks for children.
- ▶ Danger of suffocation!  
Keep children away from any packing material.



# IMPORTANT SAFETY INSTRUCTIONS

---

## Technical safety

- ▶ Before installing the coffee system, check for externally visible damage. If the coffee system is damaged, it may pose a safety hazard and must not be used under any circumstances.
- ▶ Before connecting the coffee system, check the voltage and frequency indicated on the data plate against the voltage and frequency of the household electrical supply. This data must correspond in order to prevent damage to the coffee system. If in doubt, consult a qualified electrician.
- ▶ Be certain your appliance is properly installed and grounded by a qualified technician. To guarantee the electrical safety of this appliance, continuity must exist between the appliance and an effective grounding system. It is imperative that this basic safety requirement be met. If there is any doubt, have the electrical system of the house checked by a qualified electrician.
- ▶ Reliable and safe operation of the coffee system can only be guaranteed if it is connected to the electrical supply.
- ▶ Do not connect the machine to the electrical supply using an extension cord or power bar.
- ▶ The coffee system may not be used in mobile installations such as ships.
- ▶ Unplug the appliance from the power supply immediately if you notice any damage or smell.
- ▶ Do not operate any appliance with a damaged cord or plug or after the appliance malfunctions, or has been damaged in any manner. Return appliance to the nearest authorized service facility for examination, repair or adjustment.
- ▶ Ensure that the power cord will not be pinched or damaged by any sharp edges.

## IMPORTANT SAFETY INSTRUCTIONS

---

- ▶ The power cord should not hang down. Someone could trip over it with the risk of injury and the appliance could be damaged.
- ▶ Do not let cord hang over edge of table or counter, or touch hot surfaces.
- ▶ Do not place on or near a hot gas or electric burner, or in a heated oven.
- ▶ Only use the coffee system in rooms where the ambient temperature is between +50°F (10°C) and +100°F (38°C).
- ▶ Danger of overheating! Ensure that there is sufficient ventilation around the coffee system. Do not cover it with tea towels etc. while it is in use.
- ▶ If the coffee system is installed behind a cabinet door, it may only be used with the door open. This will prevent the formation of heat and humidity and subsequent damage to the appliance and/or housing unit. Do not close the cabinet door while the coffee system is in use. Ensure the coffee system has cooled down completely before closing the door.
- ▶ Protect the coffee system from water and water spray. Do not immerse the appliance in water.
- ▶ Repairs and other work by unqualified persons to the appliance and the power cord could be dangerous. The manufacturer cannot be held liable for unauthorized work. Repairs may only be carried out by a Miele-authorized service technician.
- ▶ Repairs must only be performed by a trained technician in accordance with national and local safety regulations. Repairs and other work by unauthorized persons could be dangerous and may void the warranty.
- ▶ Defective components should be replaced by Miele original parts only. Only with original Miele parts can the manufacturer guarantee the safety of the appliance.

## IMPORTANT SAFETY INSTRUCTIONS

---

▶ For repairs, the coffee system must be disconnected from the electrical power supply.

The coffee system is only disconnected from the power supply if

- The power cord has been unplugged.  
Unplug the cord by pulling on the plug, not on the cord.
- The fuses to the household power supply are turned off.
- Any screw-in fuses in the household supply are fully unscrewed.

▶ Never open the outer casing of the machine. Tampering with electrical connections or components and mechanical parts is highly dangerous to the user and can cause operational faults or electric shock.

▶ To protect against fire, electric shock and injury to persons do not immerse cord, plugs, or coffee machine in water or other liquid.

▶ To disconnect, turn main switch to "0", then remove plug from wall outlet.

▶ Use only genuine original Miele parts. If parts or accessories from other manufacturers are used, the warranty may become void. The use of accessory attachments not recommended by Miele may result in fire, electric shock or injury to persons.

# IMPORTANT SAFETY INSTRUCTIONS

---

## Proper use

 Danger of burning and scalding from the dispensers. The liquids and steam dispensed are very hot.

► Please note:

- Keep away from the area underneath the dispensers when hot liquids and steam are being dispensed.
- Do not touch hot components.
- Hot liquid or steam could spatter from the dispensers. Ensure that the main dispenser is clean and fitted correctly.
- Water in the drip tray can also be very hot. Take care when emptying it.

 CM 6350: Danger of injury to the eyes!

Never look directly at the lighting or use optical instruments (e.g. magnifying glass) to look at it.

► Please note the following regarding water:

- Fill the water tank only with fresh, cold tap water. Hot or warm water or other liquids could damage the coffee system.
  - Change the water every day to prevent a build-up of bacteria.
  - Do not use mineral water. Mineral water will cause lime scale deposits to build up in your machine and damage it.
  - Do not use water from a reverse osmosis unit in this machine. This would damage it.
- Only fill the bean container with roasted espresso or coffee beans. Do not fill the bean container with coffee beans that have been treated with additives or with ground coffee.
- Do not pour liquids into the bean container.

## IMPORTANT SAFETY INSTRUCTIONS

---

- ▶ Do not use green (unroasted) coffee beans or mixtures of coffee beans which contain green coffee beans. Green coffee beans are very hard and still contain a certain amount of residual moisture. These can damage the coffee system grinder as soon as grinding begins.
- ▶ Do not use oily beans or beans that have been treated with caramel, sugar, or other substances. Sugar and oil will damage the coffee system.
- ▶ Only add ground coffee or cleaning tablets to the ground coffee chute.
- ▶ Do not use any caramelized ground coffee. The sugar in the coffee will stick to and block the brew unit of the coffee system. The cleaning tablets for degreasing the brew unit will not remove this type of deposit.
- ▶ Only use plain milk. Most sugary additives can clog the milk lines and damage the machine.
- ▶ If using dairy milk make sure that it has been pasteurized.
- ▶ Do not place any alcohol mixtures which are alight underneath the main dispenser. The flames could ignite plastic components and cause them to melt.
- ▶ Do not place any open flame, e.g. a candle, on or near the coffee system. The coffee system could catch fire.
- ▶ Do not use the coffee system to clean objects.

# IMPORTANT SAFETY INSTRUCTIONS

---

## Cleaning and care

- ▶ The coffee system must be disconnected from the electrical supply before cleaning or maintenance.
- ▶ Clean the coffee machine and the milk flask (supplied as standard, depending on model) daily, particularly before using for the first time (see "Cleaning and care").
- ▶ All parts of the milk system need to be cleaned thoroughly and regularly.
- ▶ Do not use a steam cleaner to clean this machine. Steam could reach electrical components and cause a short circuit.
- ▶ Descale the coffee system regularly depending on the water hardness level in your area. Descale the machine more frequently in areas with very hard water. Miele cannot be held liable for damage arising from insufficient descaling, the use of incorrect descaling agent or the use of descaling agent that is not of the appropriate concentration.
- ▶ Degrease the brew unit regularly with Miele cleaning tablets. Depending on the natural oil content of the coffee used, the brew unit can become blocked quite quickly.
- ▶ Rinsing coffee grounds down the drain can cause the sink to clog. Instead, dispose of your coffee grounds appropriately as biodegradable waste (where facilities exist) or by composting.

## IMPORTANT SAFETY INSTRUCTIONS

---

### **For machines with stainless steel surfaces:**

- ▶ Do not use sticky notes, transparent adhesive tape, masking tape or other types of adhesive on stainless steel surfaces. These damage the surface, causing it to lose its dirt repellent protective coating.
- ▶ The finish on stainless steel surfaces is susceptible to scratching. Even magnets can cause scratching.

# Guide to the appliance

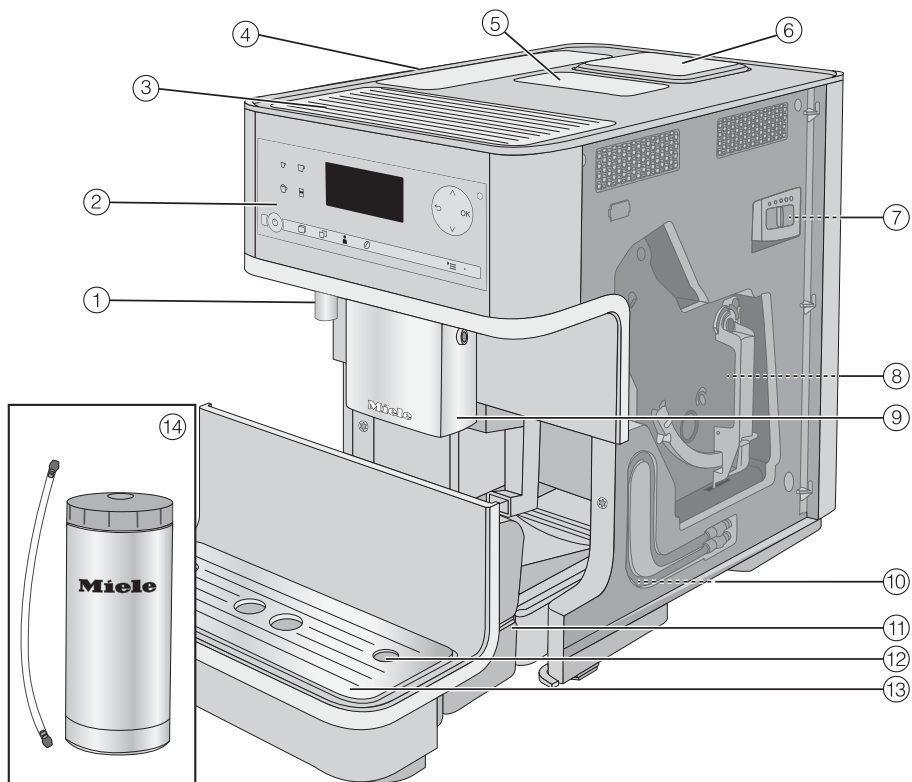

- ① Hot water spout\*
- ② Controls and display
- ③ Cup heating\*
- ④ Water container
- ⑤ Ground coffee chute
- ⑥ Bean container
- ⑦ Grinder setting (behind the service panel)
- ⑧ Brew unit (behind the service panel)
- ⑨ Main dispenser with cappuccinatore
- ⑩ Park position for milk pipework (behind the service panel)
- ⑪ Drip tray with lid and grounds container
- ⑫ Milk tube opening
- ⑬ Lower panel with drip tray cover
- ⑭ Stainless steel milk flask\*



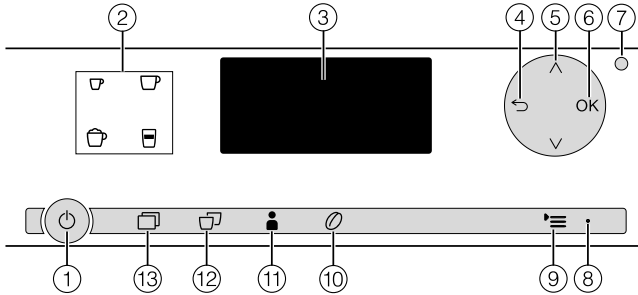

\*CM 6350







- ① **On / Off button** 

For turning the appliance On and Off
- ② **Drink buttons**

For making Espresso ,  
Coffee ,  
Cappuccino  or  
Latte macchiato 
- ③ **Display**

For showing information on current activity or status
- ④ **Back** 

For returning to the previous menu, canceling unwanted actions
- ⑤ **Arrow buttons**  

For showing more selection options in the display and highlighting a selection
- ⑥ **OK**

For confirming display messages and saving settings
- ⑦ **Optical interface**  
(for Miele Technical Service only)
- ⑧ **LED**

Flashes when the appliance is turned on and the display is black
- ⑨ **Settings** 

For displaying the "Settings" menu and changing settings
- ⑩ **Parameters** 

For displaying and changing drink settings
- ⑪ **User profiles** 

For creating and managing profiles
- ⑫ **Double portion** 

For preparing two portions of a drink
- ⑬ **Additional programs** 

other drinks: Ristretto, lungo coffee, caffè latte, hot milk, milk froth, hot water \*  
Maintenance programs

\* CM 6350

# Accessories

---

These products and other useful accessories can be ordered via the Miele Webstore, from Miele Service or from your Miele dealer.

## Included accessories

- **Measuring scoop**  
For ground coffee
- **Stainless steel milk flask MB-CM**  
For keeping milk cool longer  
(capacity approx. 2 cups / 0.5 l)

The stainless steel milk flask is not supplied with the CM 6150.

- **Miele appliance care starter set**  
Different cleaning products, e.g. Miele descaling tablets, are supplied depending on model.
- **Cleaning brush**  
For cleaning the milk pipework

## Optional accessories

Miele also offers a range of optional accessories, as well as cleaning and conditioning products for your coffee system.

- **Cleaning agent for milk pipework**  
for cleaning the milk system
- **Cleaning tablets**  
for degreasing the brew unit
- **Descaling tablets**  
for descaling the water pipework
- **Stainless steel milk flask MB-CM**  
For keeping milk cool longer  
(capacity approx. 2 cups / 0.5 l)

# Before using for the first time

## Before using for the first time

- Remove any protective coverings and notices from the machine.
- Insert the drip tray into the lower panel.
- Place the coffee machine on a flat surface that is not sensitive to water (see "Installation").

Clean the appliance thoroughly before filling it with water and coffee beans (see "Cleaning and care").

- Plug in the coffee machine (see "Electrical connection").
- Remove the water container and fill it up to the "max." mark with fresh cold water. Replace the water container (see "Filling the water container").
- Remove the bean container lid, fill it with roasted coffee beans and replace the lid (see "Filling the bean container").

## Turning on for the first time

When the coffee machine is turned on for the first time, after the welcome screen has appeared you will be asked to set the following settings:

- Language and country
- Time of day
- Tap the On / Off button .

Miele - Willkommen appears briefly on the display.

## Selecting a language

- Use the arrow keys  $\wedge$   $\vee$  to highlight the desired language. Then tap *OK*.
- Use the arrow keys  $\wedge$   $\vee$  to highlight the desired country. Then tap *OK*.

The setting is now saved.

## Setting the time of day

- Use the arrow keys  $\wedge$   $\vee$  until the time of day appears. Then tap *OK*.

The setting is now saved.

The coffee machine is now successfully set up for use. The coffee machine will heat up and rinse the pipework. Rinse water flows out of the main dispenser.

- Rinse the milk pipework (see "Rinsing the milk pipework") before making a drink with milk for the first time.

Please note that the coffee aroma and the characteristic crema only develops after the first few coffees have been made.

## Before using for the first time

---

Turn the appliance off with the On / Off  button. Do not unplug the power cord to switch off the coffee machine. If you unplug the coffee machine while using it for the first time, you will have to set it up for use again.

A larger quantity of coffee beans is ground for the first coffee drinks and powder from the coffee grounds may adhere to the cover of the drip tray.

### Water hardness

The water hardness level indicates how much calcium is dissolved in the water. The higher the calcium content, the harder the water, and the harder the water, the more often the coffee machine will need to be descaled.

The coffee machine measures the amount of water used and steam made. Depending on the level of water hardness set, more or fewer drinks can be dispensed before the appliance needs to be descaled.

Program the coffee machine to the water hardness level of your area so that it functions correctly and does not get damaged. At the correct time a prompt will then appear in the display to descale the appliance.

Your local water authority will be able to tell you the hardness of water in your area.

The water hardness level is set to 3 at the factory.

You can program four hardness levels on the machine:

°dH	gr/gal	Setting
0 - 8.4	0 - 8.7	Soft 1
8.4 - 14	8.7 - 14.6	Medium 2
14 - 21	14.6 - 21.9	Hard 3
> 21	> 21.9	Very hard 4

\* The water hardness settings in the display may differ from the water hardness level in your area. To set the correct water hardness level for your area **always** refer to the values in the chart.

### Setting the water hardness level

- Tap '≡.
- Use the arrow buttons ^∨ to select *Water hardness* and tap *OK*.
- Use the arrow keys ^∨ to select the required water hardness. Then tap *OK*.

The setting is now saved.

## Operation

To operate the coffee machine, tap the sensor buttons with your finger.

**CM 6350:** An audible signal is generated each time a button is touched. You can adjust the volume of the signal tones or switch the tones off (see "Settings – Volume").

When the following appears on the display, you are in the drinks menu:

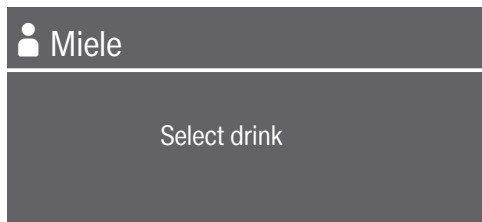

To make a coffee drink, tap one of the drink buttons.

You can find more drinks in the Additional programs  menu.

## Selecting a menu and navigating within a menu

To select a menu, tap the relevant button. You will then be able to start an action or change settings in the menu.

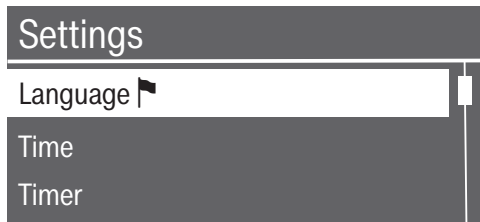

A scroll bar at the right of the display shows that additional options or text are available. Use the arrow keys  $\wedge$   $\vee$  to display them.

The setting which is currently selected will have a checkmark  $\checkmark$  beside it.

To select a setting use the arrow keys  $\wedge$   $\vee$  until the setting you want is highlighted.

To confirm the selection, tap *OK*.

## Leaving the menu or canceling an action

To exit the current menu, tap *Back*.

## Filling the water tank

⚠ Change the water **every day** to prevent a build-up of bacteria.

Only use cold, fresh tap water to fill the water tank.

Hot or warm water or other liquids can damage the coffee system.

**Do not** use mineral water. Mineral water will cause serious limescale deposits to build up in your machine and damage it.

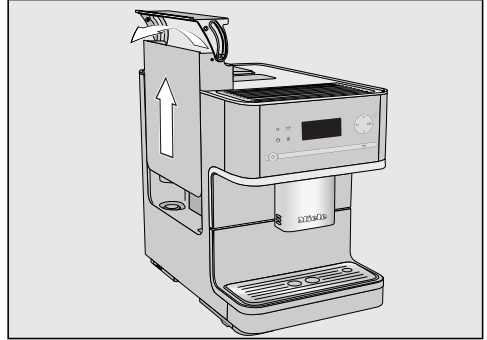

- Press the lid on the right-hand side.
- Pull the water reservoir up by the lid to remove it.
- Fill the water reservoir with fresh, cold tap water up to the "max." marker.
- Replace the water reservoir.

If the water reservoir is a little high or at a slant, check whether the surface that the water reservoir sits on is dirty. If the water reservoir is not sitting correctly, the drain valve will not be sealed.

Clean the surface if necessary.

## Filling the coffee bean container

Fill the coffee bean container with roasted coffee or espresso beans if you want to use freshly ground coffee beans for each cup of espresso or coffee.

Alternatively, you can make coffee or espresso with ground coffee (see "Making coffee drinks from ground coffee").

**Important!** Risk of damage to the grinder.

Only put roasted coffee or espresso beans in the container. Anything else, including ground coffee, will damage the grinder.

Do not pour liquids in the bean container.

**Important!** Sugar damages the coffee system.

Do not use coffee beans that have been treated with sugar, caramel, or other substances containing sugar in the coffee bean container.

Do not use green (unroasted) coffee beans or mixtures of coffee beans which contain green coffee beans. Green coffee beans are very hard and still contain a certain amount of residual moisture. These can damage the coffee system grinder as soon as grinding begins.

**Tip:** You can use a nut or seed grinder to grind green coffee beans. These types of grinder generally have a rotating stainless steel blade. You can then add the ground green coffee **portion by portion** to the ground coffee chute and make the desired coffee drink (see "Making coffee drinks from ground coffee").

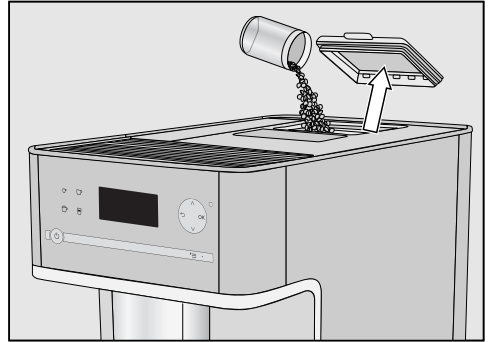

- Take the lid off the coffee bean container.
- Fill the container with roasted coffee beans.
- Replace the lid.

**Tip:** Only add enough beans to last for a few days as contact with air causes coffee beans to lose their aroma.



# Turning the machine On and Off

## Turning the appliance on

- Tap the On / Off button .

The appliance heats up and rinses the lines. Hot water will run out of the main dispenser.

When **Select drink** appears on the display, you can make drinks.

If the operating temperature exceeds 140°F (60°C) when you switch the machine on, the rinsing process will not take place.

If no buttons are touched or maintenance programs carried out, the display will turn off after approx. 7 minutes to save energy.

The LED on the right flashes as long as the machine is switched on.

- Tap any one of the buttons to wake the appliance up again to make a drink.

## Turning the appliance off

- Tap the On / Off button .

After a coffee drink has been dispensed, the pipework will be rinsed before the appliance turns off.

If you have made a drink using milk, Place milk pipe in drip tray will appear in the display.

- Insert the end of the milk pipe into the aperture in the drip tray, and then tap **OK**.

If the milk system is not rinsed out before turning off, it will have to be rinsed the next time the appliance is turned on.

## Turning off for longer periods of time

If the coffee machine is not going to be used for a longer period of time, e.g. if you are going on vacation:

- Empty the drip tray, the waste unit and the water reservoir.
- Clean all parts thoroughly, including the brew unit.
- Switch off the machine and unplug the power cord to disconnect it.

The time of day will not be saved. It will have to be reset next time the appliance is turned on.

# Cup heating

---

(CM 6350)

Cups should always be pre-heated to allow the flavor of the coffee to develop and be retained.

The smaller the volume of the coffee/espresso and the thicker the cup, the more important it is to pre-heat the cup.

You can pre-heat cups or glasses on the cup heating surface on the top of the coffee machine.

The cup heating function must first be switched on.

The cup heating surface will be heated continually until the coffee system is turned off.

## To turn cup heating on or off

- Tap **☰**.
- Select **Cup heating** and tap **OK**.
- Select the required option and tap **OK**.

The setting is now saved.

## Pre-heating cups

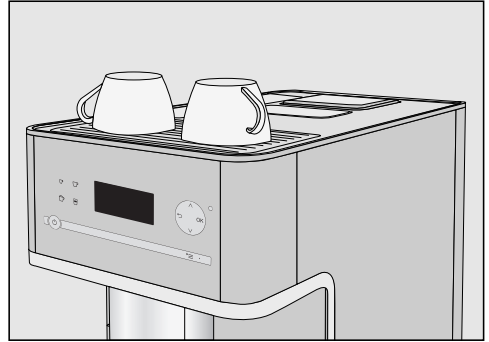

- Arrange the cups or glasses on the cup heating surface on the top of the coffee system.

## Adjusting the coffee dispensers to the cup height

---

You can adjust the main dispenser to suit the height of the cup you are using so that the coffee or espresso will not cool down as quickly and the crema will have a better consistency.

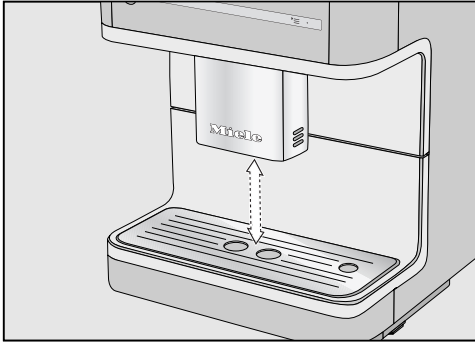

- Pull the main dispenser down until it is at the same level as the rim of the cup.  
Alternatively, push the main dispenser up until there is enough room to fit a larger cup or mug underneath.

## Preparing beverages

You can choose from a variety of specialty coffees:

- **Ristretto** ☐ is a concentrated, strong espresso. The same quantity of coffee powder as for an espresso is prepared with very little water.
- **Espresso** ☐ is a strong, aromatic coffee with a thick hazelnut-brown cream layer – the crema – on top. Use espresso-roasted coffee beans for preparing espresso.
- **Coffee** ☐ differs from espresso by the increased amount of water and the roast of the beans. Use coffee beans of the correct roast to make coffee.
- **Lungo coffee** ☐ is a coffee with significantly more water.

⚠ Danger of burning and scalding from the dispensers.  
The liquids and steam dispensed are very hot.  
Keep away from the area underneath the dispensers when hot liquids and steam are being dispensed.  
Do not touch hot components.

### Making a coffee drink



- Place a cup under the main dispenser.
- Select a drink.
  - Espresso ☐
  - Coffee ☐
  - in Additional programs ☐:  
Ristretto, Long Coffee

Dispensing will start.

To ensure that any residues from the factory testing process are removed from the brewing system, please discard the first two cups of coffee when using the appliance for the first time.

## Canceling preparation

To cancel preparation:

- Tap the drinks button or  for drinks from Additional programs again.

Drink preparation will be canceled.

**Tip:** You can cancel making a drink by tapping *OK* as soon as *Stop* appears in the display.

When making **coffee with milk** or **two portions of a drink** you can cancel each stage individually.

- Tap *OK*.

Drink preparation will be canceled.

## Double portion

You can dispense two portions into one cup or dispense two portions into two cups at the same time.



- To fill two cups at the same time, place a cup under each coffee spout.

- Tap .

- Select a drink.

Two portions of the desired drink will be dispensed from the main dispenser.

**Tip:** Tip: If, after a while, you have not tapped one of the drink buttons, the "Double portion"  option will revert back to single portions.

# Preparing beverages

---

## Coffee pot: Making several cups of coffee one after the other

With the **Coffee pot** function you can make several cups of coffee one after the other automatically - up to max. 1 quart (1 liter) - to fill a coffee pot, for example. In this way, up to eight cups of coffee can be made.

- Place a sufficiently large container under the main dispenser.
- Tap .
- Use the arrow keys  $\wedge$   $\vee$  to highlight **Coffee pot**. Tap **OK**.
- Use the arrow keys  $\wedge$   $\vee$  to highlight the desired number of cups (3 to 8). Then tap **OK**.
- Follow the instructions given.

Each portion of coffee will be brewed and dispensed individually. The display will inform you about the progress.

### Canceling preparation

- Touch **OK** when **Stop** appears on the display.

Dispensing will stop.

### Canceling Coffee pot

- Tap .

Coffee pot dispensing will stop.

## Making coffee drinks from ground coffee

To make drinks using ready-ground coffee, add a portion of ground coffee to the ground coffee chute.

This allows you to make a decaffeinated coffee, if the bean container is already filled with regular coffee beans for example.

The coffee system will automatically recognize that ground coffee has been placed in the chute.

Only **one** portion of coffee or espresso can be prepared at a time when using ground coffee.

Add a **maximum** of two level spoons of coffee to the ground coffee chute. If too much is added, the brew unit will not be able to process the coffee.

### Adding ground coffee

The coffee system will use all the ground coffee that has been added to the chute to make the next coffee.

Use the scoop supplied with the appliance to ensure that the correct amount of ground coffee is used.

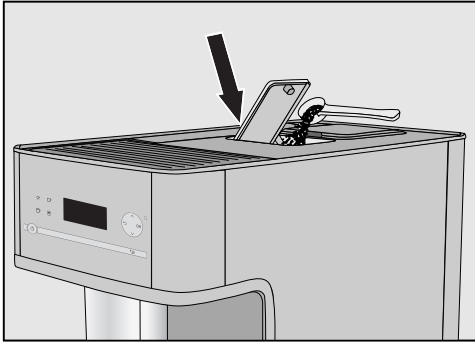

- Open the ground coffee chute.
- Use the measuring spoon to add ready ground coffee to the chute.

Add a **maximum** of two level spoons of coffee to the ground coffee chute.

- Close the coffee chute.

Use ground coffee appears on the display.

### Making coffee with ground coffee

If you want to make a drink with pre-ground coffee:

- select **Yes** and tap **OK**.

You can now choose which coffee drink to make with ground coffee.

- Place a cup under the main dispenser.
- Select a drink.

The coffee machine will now prepare the desired drink.

If you select **No** and confirm with **OK**, the ground coffee is emptied unused into the waste container. The appliance will rinse itself.

### Preparing the hot water (CM 6350)

 **Caution!** Danger of burning and scalding. The water dispensed is very hot.



- Place a suitable container under the hot water spout.
- Tap .
- Select **Hot water** and tap **OK**.

Hot water will run into the container under the hot water spout.

To cancel preparation

- tap **OK**.

Drink preparation will be canceled.

# Preparing beverages

---

## Preparing user profile drinks

You can enter individual profiles to cater for different tastes and preferences.

If you have already created your own profile (see "User Profiles"), you can select this to make a drink according to your own taste.

- Tap .
- Select the profile with the arrow buttons  $\wedge$   $\vee$  and tap *OK*.

The name of the selected user profile will appear in the top of the display.

You can now make your drink.



## Making coffee with milk

**⚠ Caution!** Danger of burning and scalding from the main dispenser. Liquids and steam dispensed will be very hot.

Only use plain milk. Most sugary additives can clog the milk lines, and damage the appliance.

As soon as you select a drink containing milk the appliance will start to heat up. The milk will be drawn up into the central spout where it is heated by steam and also frothed for drinks requiring milk froth.

If you have not made any milk drinks for a while, rinse the milk system thoroughly before making the first drink to ensure any bacteria is flushed out.

The following drinks with milk can be made:

- **Cappuccino** ☕ consists of approx. 2/3 milk froth and 1/3 espresso.
- **Latte macchiato** ☕ consists of 1/3 each of hot milk, milk froth and espresso.
- **Caffè latte** ☕ consists of hot milk and espresso.

**Hot milk** and **milk froth** can also be made.

**Tip:** Using cold milk (< 50°F/10°C) will produce the perfect milk froth. You can select milk with a fat content according to preference. With whole milk (at least 3.5% fat), the milk froth will be slightly creamier.

### Milk flask

(Supplied with CM 6350)

The stainless steel flask keeps milk cool for longer. Good milk froth can be made with cold milk (< 50°F/10°C).

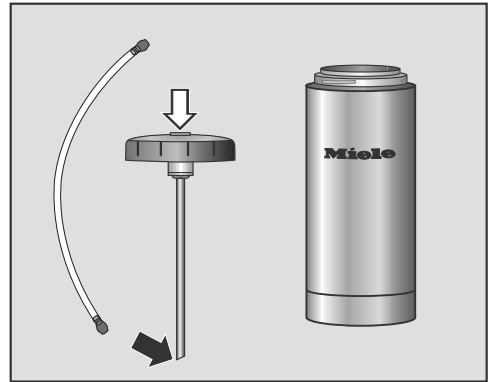

- Connect the stainless steel suction tube to the inside of the lid. Make sure that the slanted end is pointing downwards as shown.
- Fill the milk flask up to max. 3/4" (2 cm) below the rim with milk. Seal the milk flask with the lid.
- Connect the milk tube to the top of the lid. Make sure that the connecting piece clicks into position.

## Making coffee with milk

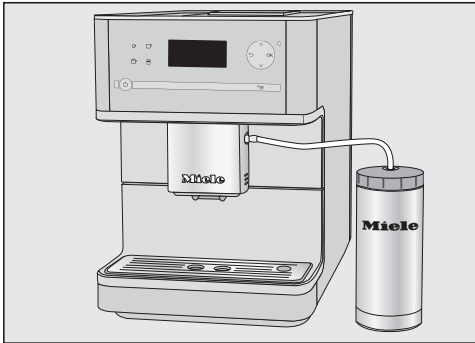

- Place the milk flask on the right-hand side of the coffee system. Connect the other end of the milk tube to the main dispenser.

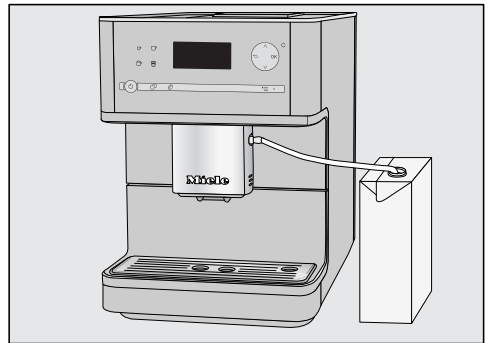

- Connect the milk pipe to the aperture in the main dispenser.
- Place a container with sufficient milk beside the coffee machine.
- Place the end of the milk tube in the container making sure that it is sufficiently immersed in the milk.

### Using milk cartons or bottles

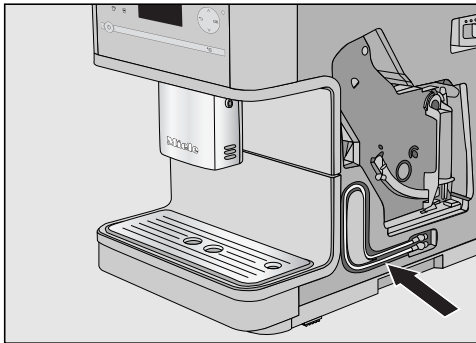

The milk tube for cartons and other suitable containers is located behind the appliance front.

### Preparing drinks with milk

- Place a suitable container under the main dispenser.
- Select a drink.
  - Cappuccino ☕
  - Latte macchiato ☕
  - in Additional programs: Caffè Latte, Hot Milk, Milk Froth

The drink will now be made.

## Grinder setting

When the beans are ground correctly, the coffee or espresso will flow evenly into the cup with a good crema. The crema should have an even nut-brown colour.

The grinder setting you select will be used for all coffee drinks.

There are various ways to tell whether the coffee grinder is set correctly.

The coffee is ground **too coarse**, if

- espresso or coffee flows into the cup too quickly.
- the crema is very pale and uneven.

Set a finer grinder setting.

The coffee is ground **too fine**, if

- espresso or coffee flows into the cup very slowly.
- the crema is dark brown.

Set a coarser grinder setting.

To avoid damaging the grinder, please note the following:

Only adjust the grinder one setting at a time.

Grind the coffee beans again if you want to adjust the grinder to the next setting.

- Open the appliance door.

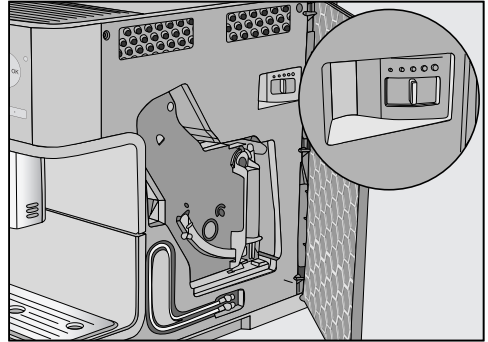

- Push the slide control one setting to the left (for finer grinding) or one setting to the right (for coarser grinding).
- Close the appliance door.

Opening the appliance resets the internal counter for emptying the drip tray and the grounds container.

- Empty the drip tray **and** grounds container.
- Prepare a coffee drink.

After that, you can adjust the grinder setting again.

The altered grinder setting will not be used until after the second coffee has been dispensed.

# Amount of coffee, brew temperature and pre-brewing

---

You can adjust the amount of coffee, the brew temperature and pre-brewing individually for each coffee drink. To do this, first select the drink from the Parameters  $\mathcal{O}$  menu and then adjust the drink parameters.

- Tap  $\mathcal{O}$ .
- Select the drink you want and tap *OK*.

The current settings for the amount of coffee, brewing temperature and pre-brewing will be displayed for this drink.

- **Select** Amount of coffee, Brew temperature or Pre-brewing.
- Select the setting you want and tap *OK*.

The setting is now saved.

## Amount of coffee

The coffee system can grind and brew 6-14 g of coffee beans per cup. The greater the quantity, the stronger the coffee.

There are various ways to tell whether the amount of coffee is set correctly.

The amount of coffee is **too low**, if

- espresso or coffee flows into the cup too quickly.
- the crema is very pale and uneven.
- the espresso or coffee lacks body.

Increase the amount of coffee so that more ground coffee is brewed.

The amount of coffee is **too high**, if

- espresso or coffee flows into the cup very slowly.

- the crema is dark brown.
- the espresso or coffee tastes bitter.

Decrease the amount of coffee so that less ground coffee is brewed.

**Tip:** If the coffee is too strong for you or it tastes bitter, try a different type of bean.

## Brewing temperature

The ideal brewing temperature will depend on:

- the type of coffee,
- whether an espresso or a coffee is being prepared, and
- the altitude of the region.

If the coffee system is located at more than 6562 ft. (2000 meters) above sea level, the brewing temperature needs to be set lower due to the change in pressure. This is because the boiling point for water at a high altitude above sea level is lower than the boiling point for water at sea level.

**Tip:** Not all types of coffee can withstand high temperatures. Certain types are too delicate - the crema on top would not be as good and the taste would be impaired.

# Amount of coffee, brew temperature and pre-brewing

---

## Pre-brewing ground coffee

When the pre-brewing function is turned on, the freshly ground coffee is first moistened with a little hot water. Then the remaining water is forced through the moistened coffee at high pressure. This helps release the flavor of the coffee.

You can set pre-brewing for a normal length of time or an extra long length of time. Alternatively, you can turn off the "Pre-brewing" function.

The machine is supplied with the "Pre-brewing" function turned off.

# Portion size

---

The flavor of the coffee produced depends not just on the type of coffee used, but also on the amount of water used.

You can program the amount of water to suit the size of your cups and the type of coffee you are using.

For coffee drinks that use milk you can also set the amount of milk or milk froth to be dispensed with these drinks. Additionally, you can set the portion sizes for hot milk and milk froth alone.

Each type of drink has a maximum portion size that can be programmed into the appliance. The coffee machine halts preparation of the coffee once this portion size has been reached. The maximum possible portion size for this type of drink is then saved in the appliance.

If the water container becomes empty while making a drink, the appliance will stop programming the portion size. The portion size will **not** be saved.

There are two ways of initiating the programming of the portion size:





- By tapping the drink button when you are preparing a coffee; or
- by selecting **Portion size** in the **Parameters**  menu.

The changed portion size is always saved in the current User profile. The name of the current profile appears in the top left-hand side of the display.

## Canceling quantity programming

- Touch the drinks sensor again or the  sensor for drinks from **Additional programs** again.

## Changing the portion size during drink preparation

You can adapt the portion size for espresso , coffee , cappuccino , and latte macchiato  directly during preparation and save it.

- Place a cup under the main dispenser.
- Tap the sensor button for the desired drink until **Change** appears in the display.

The desired drink is prepared and **Save** appears in the display.

- When the cup is filled to the desired level, tap **OK**.

If you want to change the the drink amount for coffee specialties with milk, the ingredients are the drink are saved one after the other during preparation.

- When the quantity for each ingredient reaches the desired level, tap **OK**.

The programmed mix of ingredients and portion sizes will now be dispensed every time that particular drink is selected.

### Changing the portion size in the Parameters menu

You can adapt the portion sizes for **lungo coffee**, **caffè latte**, **hot milk**, and **milk froth** using the "Parameters" menu.

- Place a suitable container under the main dispenser.
- Tap .
- Select the desired drink.
- Select **Portion size** and tap **OK**.

From this point onwards the procedure is identical to programming the portion size during drink preparation.

### Changing the portion size for different user profiles

You can set the portion size for individual drinks for each user profile.

- Tap .
- Select the user profile.

The name of the current user profile is shown at the top left of the display.

Now you can adjust the portion sizes as described above.

# User profiles

---

If the coffee system is used by several people with different coffee preferences, you can create individual user profiles in addition to the Miele profile.

In each user profile, you can make settings for individual drinks (portion size, amount of ground coffee, brewing temperature and pre-brewing).

The name of the current user profile is shown at the top left of the display.



## Accessing a user profile

- Tap .

You can now create a user profile.

If you have allocated a profile in addition to the Miele standard user profile, you have the following options:

- **Select profile** from the user profiles that have already been allocated.
- **Change name** if the name of a user profile needs to be changed.
- **Delete profile** if you want to delete a user profile.
- **Change profile** to set whether the coffee system automatically always reverts to the Miele standard user profile or retains the last selected user profile.

**Tip:** Tap  or "Profile"  to return to the main menu.

## Creating a user profile

- Use the arrow buttons  $\wedge$   $\vee$  to select **Create profile** and tap **OK**.

Letters will appear in the display that you can select with the arrow buttons. You can use the arrow buttons to select from numbers, upper case and lower case letters.

- Tap arrow buttons  $\wedge$   $\vee$  to select the character and then tap **OK**.

The character will then appear in the line above.

- Repeat the process until the desired name appears in the display line above.

**Tip:** You can delete the last character entered by tapping .

### When you have finished entering a name and want to save it,

- use the arrow keys  $\wedge$   $\vee$  to highlight the check  and tap **OK**.

### If you do not want to save what you have entered,

- tap and hold  until all characters have been deleted and the coffee system jumps back to the previous menu.

The last created profile is selected as the current profile.



## Selecting a user profile

This selection is only possible if a profile has been allocated in addition to the Miele standard user profile.

- Use the arrow buttons  $\wedge \vee$  to select *Select profile* and tap *OK*.
- Select the profile with the arrow buttons  $\wedge \vee$  and tap *OK*.

The name of the current user profile is shown at the top left of the display.

## Changing the name

This selection is only possible if a profile has been allocated in addition to the Miele standard user profile.

- Use the arrow buttons  $\wedge \vee$  to select *Change name* and tap *OK*.
- Proceed the same as with "Create profile":
  - Select  $\leftarrow$  to delete a character.
  - To enter new characters, highlight the relevant character and confirm with *OK*,
  - Save the new name by selecting  $\checkmark$  in the display and tapping *OK*.

## Deleting a user profile

This selection is only possible if a profile has been allocated in addition to the Miele standard user profile.

- Use the arrow buttons  $\wedge \vee$  to select *Delete profile* and tap *OK*.
- Select the profile you wish to delete.
- Tap *OK*.

A check  $\checkmark$  will appear after the name and the user profile will be deleted after a short time.

## Changing a user profile

You can program the coffee system so that it changes back to the Miele standard profile automatically after each drink is dispensed, so that the Miele profile is always active when the appliance is switched on or so that it retains the most recently selected profile.

- Select *Change profile* and tap *OK*.

You now have the following options:

- *Manually*: The selected user profile remains active until you select another user profile.
  - *After each use*: The appliance will change back to the Miele standard user profile automatically after a drink is dispensed.
  - *When turned on*: Each time the appliance is switched on it will automatically select the Miele standard user profile regardless of which user profile was set before the appliance was last switched off.
- Select the required option and tap *OK*.

# Settings

---

## Accessing the "Settings" menu

- Tap '☰.

Now you can check or change any settings.

The check ✓ next to the individual entry shows you which setting is currently active.

Tap ← if you want to access the previous menu.  
Tap '☰ to return to *Select drink*.



## Changing and saving settings

- Tap '☰.
- Select the setting you wish to change with the arrow keys ^ v and tap *OK*.
- Use the arrow keys ^ v to highlight the required option. Then tap *OK*.

The setting is now saved.

## Setting options

The factory default for each option is indicated by \*.

Menu item	Available settings
Language 	German*, English and other languages Country
Time	Clock format – 12 h / 24 h* Set
Timer	Set : Turn on at / Turn off after (12:30)* / Turn off at Activate : Turn on at (Yes / No*) / Turn off at (Yes / No*)
Eco mode	On* / Off
Lighting	Set the brightness
Info	Number of drinks – Total no. of uses / Espresso / Coffee / Coffee Americano / Cappuccino / Latte macchiato / Caffè latte / Milk froth / Hot milk / Hot water No. of uses until appliance needs descaling: No. of uses until brew unit needs degreasing:
System lock 	On / Off*
Water hardness	Soft Medium Hard* Very hard

## Settings

<b>Menu item</b>	<b>Available settings</b>
Display brightness	Set the brightness
Volume	Buzzer tones Keypad tone
Cup heating	On / Off*
Showroom program	Demo mode (On / Off*)
Factory default	Do not reset Reset

The lighting, cup heating and volume functions are only available on the CM 6350.

## Language

You can select the language (and country variant of that language) for all display text.

**Tip:** If you select the wrong language by mistake, you can find the "Language" option by following the flag symbol .

## Time of day

You can set the clock display and the time of day.

### Clock Format

Available options are:

- 24-hour display (24 h)
- 12-hour display (12 h)

### Setting

Use the arrow keys  $\wedge$   $\vee$  to set the hours and minutes.

## Timer

The timer offers the following options:

The coffee system:

- switches on at a particular time, e.g. in the morning for breakfast (Turn on at).
- switches off at a particular time (Turn off at),
- switches off after a particular length of time if no buttons have been pressed (Turn off after).

For Turn on at and Turn off at to be set, the timer must be **activated**.

### Turn on at:

Please note that the coffee system will **not** turn on at the time specified if you have activated the system lock.

Use the arrow keys  $\wedge$   $\vee$  to set the hours and minutes.

If the coffee system has turned itself on **three times** via the Turn on at timer function and no drinks have been dispensed, the machine will not switch itself on again automatically. This prevents the coffee system from switching itself on unnecessarily, for example, while you are away on vacation. The programmed times will, however, remain in memory and will be reactivated after manually switching the machine on again.

# Settings

---

## Turn off at

Use the arrow keys  $\wedge \vee$  to set the hours and minutes.

In the event of a longer absence the programmed times will remain in memory and will be reactivated after manually switching the machine on again (see "Turn on at").

## Turn off after

If none of the keys have been pressed or no drink has been prepared, the coffee system will turn itself off after 30 minutes to save energy.

You can change this pre-setting using the arrow buttons  $\vee \wedge$  to a time between 15 minutes and 9 hours.

## Activating and deactivating the timer

When the system lock is activated, the Turn on at option for the timer cannot be selected.

- Select the timer function you want to use.

The selected option will have a  next to it.

- Tap the arrow button  $\vee$  repeatedly until *Accept* is highlighted. Then tap *OK*.

## Eco mode

Eco mode is an energy-saving mode.

If Eco mode is switched on, the coffee machine will heat up anew every time a drink is made, so that making a drink takes longer.

If Eco mode is turned off, significantly more energy is used. The coffee machine heats up for the first drink preparation after being switched on. After that the appliance remains heated up and drinks can be prepared without having to wait very long.

The coffee machine will indicate that the energy consumption has been altered.

## Lighting

(CM 6350)

Change the brightness using the arrow buttons  $\wedge \vee$ .

If no keys are touched or maintenance programs carried out, the lighting will turn off after approximately 7 minutes to save energy.

**Tip:** To switch off the lights, touch the arrow buttons  $\vee$  until no more segments are filled in and *Turned off* appears.

## Info (displaying information)

Under the Info menu option, you can choose to display the number of portions made for each type of drink.

You can also see whether there are more than 50 portions before the next descaling or degreasing of the brew unit (No. of uses until).

**Tip:** To return to the previous display, tap *OK*.

## Locking the coffee system (System lock )

You can lock the coffee system to prevent it being used without your knowledge, by children, for example.

## Activating and deactivating the system lock

When the system lock is activated, the timer settings for *Turn on at* are deactivated. The coffee system will **not** switch on at the time set.

## Temporarily overriding the system lock

While the message *Press and hold the OK button for 6 seconds to unlock* is in the display,

- tap *OK* for 6 seconds.

As soon as the coffee system is turned off, the system is locked again.

## Water hardness

See "Before using for the first time" for information about water hardness.

## Display brightness

Change the display brightness using the arrow keys  $\wedge \vee$ .

## Volume

(CM 6350)

The volume of the alarm and the sensor buttons can be set using the arrow buttons  $\wedge \vee$ .

**Tip:** To switch off the tones, touch the arrow buttons  $\vee$  until no more segments are filled in and *Turned off* appears.

## Cup heating

(CM 6350)

See "Cup heating" for more information.

# Settings

---

## Factory default setting

You can reset the settings back to the ones which were set when the coffee system was delivered - the factory default settings.

The number of drinks and the appliance status (No. of drinks until ...) cannot be reset.

Please refer to the "Setting options" chart for the factory settings that are shown in bold.

The following settings will **not** be reset:

- Language
- Time of day

## Showroom program (Demo mode)

Do not activate this setting for domestic use.

The coffee system can be presented in Miele Showrooms of retail stores with the Showroom program function. The lighting will come on, but drinks cannot be dispensed and other actions cannot be carried out.

If you activate the Demo mode, you cannot turn the appliance off with the On / Off button .





The coffee system must be cleaned regularly to prevent a build-up of bacteria.

## Overview

Recommended frequency	What do I have to clean / maintain?
<b>Daily</b> (at the end of the day)	Water container
	Grounds container
	Drip tray and drip tray cover
	Stainless steel milk flask
<b>Once a week</b> (more often if heavily soiled)	Main dispenser with cappuccinatore
	Brew unit
	Area underneath the brew unit
	Housing (particularly important immediately after descaling the appliance)
<b>Once a month</b>	Bean container and ground coffee chute
<b>When prompted</b>	Milk pipework
	Brew unit (degrease with the cleaning tablets)
	Descaling the appliance

# Cleaning and care

---

## Clean by hand or in dishwasher

The following must be cleaned **by hand only**:

- Stainless steel central spout cover
- Brew unit
- water reservoir lid
- Bean container lid
- Stainless steel milk flask
- Lower panel

Some components of the coffee system are dishwasher-safe. However, cleaning these in the dishwasher frequently can cause them to become discolored due to regular contact with food residues (e.g. tomatoes) in the dishwasher. The surface of these components can also become damaged.

The following parts are **dishwasher-safe**:

- Drip tray and lid
- Drip tray cover
- Waste unit
- Water container
- Central spout (without stainless steel cover)

 Danger of burning and scalding on hot components or by hot liquids! Always allow the coffee machine to cool down before cleaning it. Caution: Water in the drip tray can be very hot.

 Do not use a steam cleaner to clean this machine. Steam could cause a short circuit.

It is important to clean the machine regularly as used coffee grounds go mouldy quickly. Milk residue can spoil and clog the milk pipework.

All external surfaces are susceptible to scratching. Scratches on glass surfaces could even cause a breakage. Contact with unsuitable cleaning agents can discolor the external surfaces. Wipe up any spillages or splashes of descaling agent immediately.

**To better maintain your appliance avoid the following:**

- Cleaning products containing soda, ammonia, acid, or chloride
- Cleaners containing solvents
- Lime removers
- Stainless steel cleaners
- dishwasher detergent,
- Oven cleaners
- Abrasive cleaning agents, e.g. powder cleaners and cream cleaners
- Scouring pads, such as pot scrubbers and brushes, or used sponges that still contain abrasive cleanser residue
- Eraser sponges
- Metal scrapers

Glass cleaners may be used to clean the exterior. However **do not** allow them to sit or "puddle", this can cause damage to the surface.

**Remove the cleaner promptly.**

# Cleaning and care

## Drip tray and grounds container

Clean the drip tray and grounds container **every day** every day to avoid unpleasant smells and mildew.

The grounds container is located in the drip tray. Water from rinsing also collects in the grounds container.

A prompt will appear in the coffee system display when the drip tray and/or the grounds container is full and needs to be emptied. Empty the drip tray **and** the grounds container.

### Danger of burns.

If the rinsing process has just finished, wait a while before removing the drip tray as the water used for rinsing will run out of the coffee spouts.

- Push the main dispenser up as far as it will go.

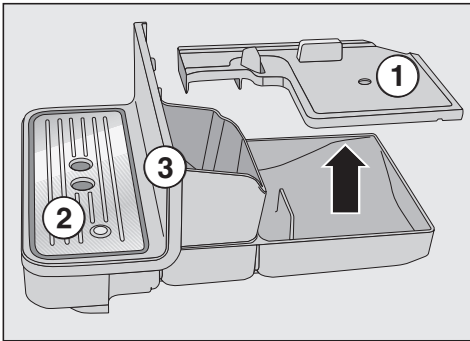

- Then pull the drip tray carefully out of the appliance. Take the lid (1) off.
- Empty the drip tray **and** grounds container.

- Remove the drip tray cover (2) and the lower panel (3).

- Clean all parts thoroughly.

Clean the lower panel by hand only using warm water and a little washing-up liquid.

All other parts are dishwasher safe.

- Clean the inside of the appliance underneath the drip tray.
- Reassemble all parts and place the drip tray back in the coffee system.

Make sure the drip tray has been pushed into its niche as far as it will go.

## Drip tray cover

- Remove the drip tray cover.
- The drip tray cover can be cleaned in the dishwasher or by hand using warm water and dishwashing liquid.
- Dry the drip tray cover thoroughly.

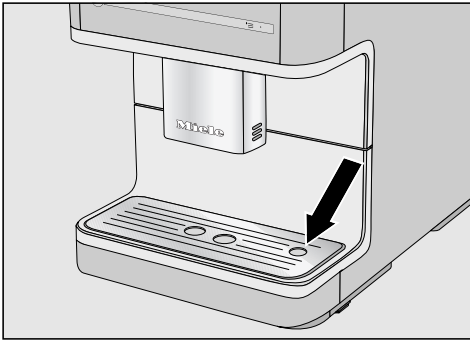

- Refit the drip tray cover making sure that it is correctly fitted (see illustration).

## Water container

Clean the water reservoir lid **by hand only** using warm water and dishwashing liquid.

- Press the lid on the right-hand side.
- Pull the water reservoir up by the lid to remove it.

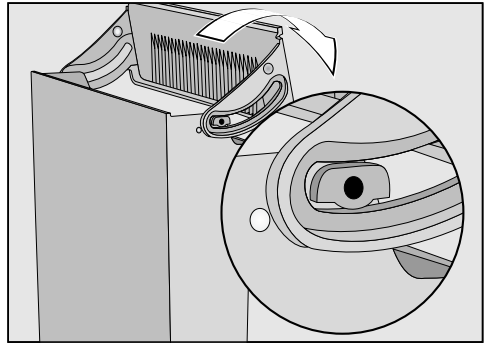

- Take the lid off the container and wash it by hand.
- The water reservoir can be cleaned in the dishwasher, or by hand using warm water and dishwashing liquid. After cleaning, dry the water reservoir.
- Carefully clean the surface the water reservoir sits on, particularly the slots.
- Fit the lid back on the container.

Make sure that the valve, the underside of the water reservoir and the surface the water reservoir sits on are clean. Otherwise the water reservoir will not sit correctly.

# Cleaning and care

## Stainless steel water intake valve filter

The stainless steel water intake valve filter is located in the recess for the water container.

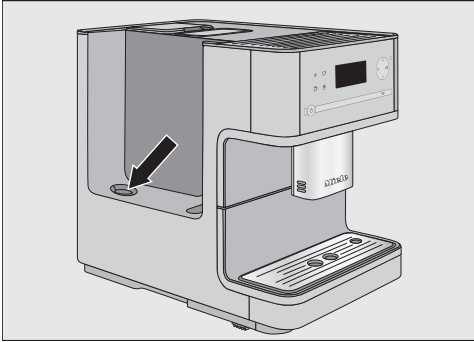

Particles in the water can collect on the fine mesh in the filter. Therefore the stainless steel filter should be checked monthly for soiling.

- Remove the water container.

Clean the stainless steel filter with water only **without** detergent in order to avoid possible unpleasant flavors.

- Check the stainless steel filter for soiling and clean it if necessary, e.g. with a damp cotton swab.
- Replace the water container.

## Main dispenser with cappuccinatore

Clean the main dispenser cover **by hand** only using warm water and dishwashing liquid.

All other components are dishwasher safe.

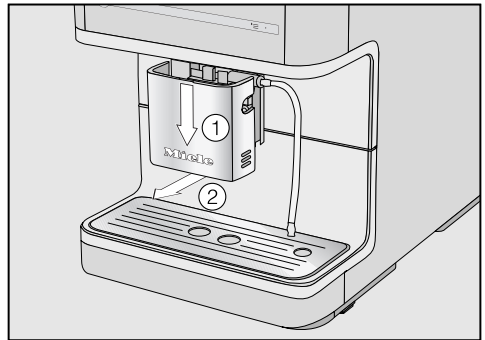

- Push the main dispenser right down and remove the stainless steel cover by pulling it off towards you.

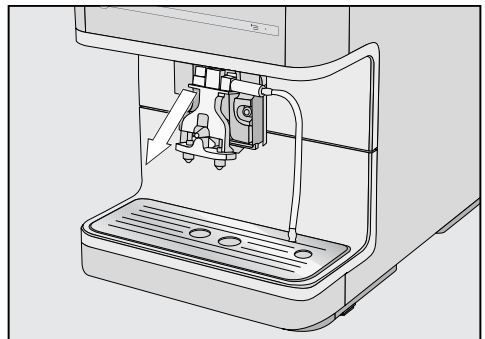

- Pull the dispensing unit off towards you.

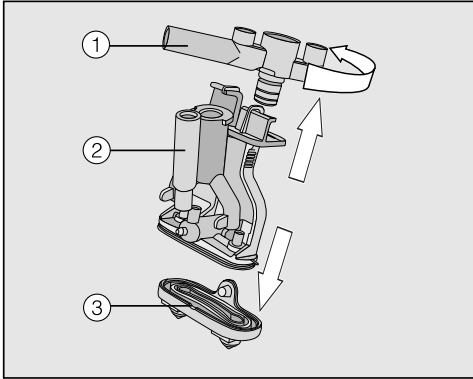

- Twist the upper section ① with the holder for the milk pipework and pull it off. Then pull the Y-shaped piece ② off. Remove the dispensing spouts ③.

- Clean all parts thoroughly.

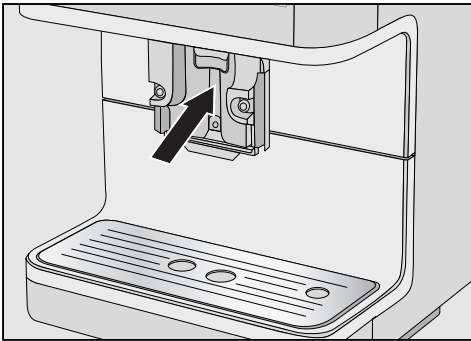

- Clean the surfaces of the main dispenser with a damp cloth.

If the milk pipe is blocked, clean it under running water with the brush supplied:

- Insert the brush in the tube and move it back and forth as far as it will go until all milk residue has been removed.
- Fit the dispensing unit back together.
- Push the dispensing unit back onto the main dispenser. Press firmly to ensure the spouts at the bottom connect correctly with the edge of the dispenser.
- Replace the stainless steel cover and connect the milk pipe if applicable.

## Cleaning and care

---

### Stainless steel milk flask

(CM 6350)

The milk flask should be taken apart and cleaned every day.

- Clean all parts **by hand only** using warm water and dishwashing liquid. Use the cleaning brush supplied to remove milk residue from the milk pipework if necessary.
- Rinse all parts carefully under running water.

Residual dishwashing liquid can affect the taste of milk from the appliance and the quality of the milk froth.

- Dry all parts thoroughly.
- Reassemble the milk flask.

### Milk pipework

 Make sure that the milk pipework is cleaned regularly and thoroughly. Milk contains natural bacteria that will multiply if the pipework is not sufficiently clean. Contamination in the coffee machine can be a health hazard.

The milk pipework must be cleaned at least once a week. A message in the display will prompt you when this needs to be done.

- Confirm the message with **OK**.

When you confirm the message **Clean milk pipework with OK**, the internal counter for the cleaning interval will be reset. You will **not** be reminded again.

There are two options for cleaning the milk pipework:

- You can remove and dismantle the central spout with its integrated cappuccinatore and either wash it in the dishwasher or by hand with hot water and a little washing-up liquid (see "Central spout with integrated cappuccinatore").
- Or you can clean the milk pipework using the **Clean milk pipework maintenance** program together with the Miele cleaning agent for milk pipework (see "Maintenance program - Cleaning the milk pipework").



## Bean container and ground coffee chute

 **Danger of injury from the grinder!**  
Switch off the machine and unplug the power cord to disconnect the machine before cleaning the bean container.

Coffee beans contain oils which can deposit on the walls of the bean container and hinder the flow of the beans. Therefore, clean the bean container regularly with a soft cloth.

**Tip:** Use a vacuum cleaner to remove any coffee residues from the bean container and the ground coffee chute.

- Open the bean container.
- Remove any coffee beans.
- Clean the bean container with a dry, soft cloth.

The coffee bean container can now be refilled.

If necessary, clean the ground coffee chute:

- Open the ground coffee chute and remove any ground coffee residue.

## Housing

If soiling is not removed promptly, it could cause the surface of the appliance to alter or discolor. Remove any soiling immediately.

Make sure that water cannot get behind the display.

The surfaces are susceptible to scratching. Contact with unsuitable cleaning agents can alter or discolor the surfaces.

Ensure that any splashes of descaling solution are wiped up immediately.

- Turn the coffee system off.
- Clean the front of the appliance with a clean sponge and a solution of warm water and dishwashing liquid. Dry using a soft cloth.

# Cleaning and care

---

## Care programs

The following maintenance programs are available:

- Rinsing the coffee system
- Rinsing the milk pipework
- Cleaning the milk pipework
- Degreasing the brew unit
- Descaling the machine

Perform the respective maintenance program when prompted to do so in the display. You will find more information in the following pages.

### Accessing the "Maintenance" menu

- Tap .
- With the arrow key  $\wedge$ , select Maintenance. Then tap *OK*.

Now you can select a maintenance program.

## Rinsing the coffee system

You can rinse the water and coffee pipework of the coffee machine manually.

After a coffee has been dispensed, the appliance is rinsed before it turns off. This removes any residual coffee grounds.

- Tap .
- Select *Maintenance* and tap *OK*.
- Select *Rinse appliance* and tap *OK*.

The piping will now be rinsed through.

You may also be prompted to insert the end of the milk pipe into the drip tray.

## Rinsing the milk pipework

Milk residue can clog up the milk pipes and so the milk pipework should be rinsed regularly. If a drink has been made using milk, the prompt to insert the end of the milk tube into the drip tray will appear at the latest when you switch the appliance off.

You can also rinse the milk pipework manually.

- Tap .
- Select Maintenance and tap OK.
- Select Rinse milk pipework and tap OK.

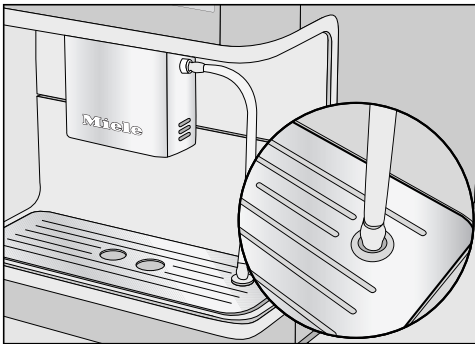

- When prompted, place the end of the milk tube into the right-hand aperture in the drip tray.
- Tap OK.

The milk pipework will now be rinsed.

## Cleaning the milk pipework with the maintenance program

We recommend using the Miele milk pipework cleaning agent for cleaning the milk pipework. This has been specially developed for use with Miele coffee machines and prevents subsequent damage.

It is available from Miele dealers, Miele Service or [www.miele-store.com](http://www.miele-store.com)

The maintenance program Clean milk pipework lasts about 15 minutes.

- Tap .
- Select Maintenance and tap OK.

The cleaning process cannot be cancelled once it has started. The process has to be completed through to the end.

- Select Clean milk pipework and tap OK.

The process will start.

- Follow the instructions in the display.

Place milk pipe in cleaning agent appears on the display.

### Making a cleaning solution:

- Dissolve the powder in a container with approx. 1 cup (200 ml) of luke-warm water. Stir the solution with a spoon until it has fully dissolved.

## Cleaning and care

---

### Carrying out the cleaning process:

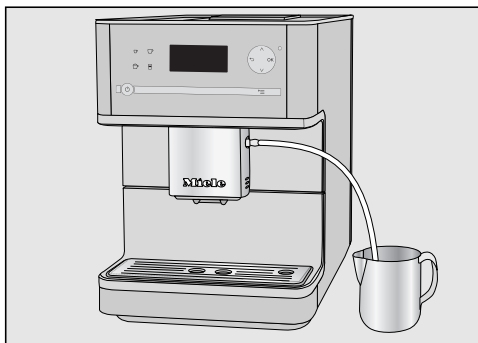

- Place the container next to the appliance and hang the milk pipe in the solution. Make sure it is placed far enough into the cleaning solution.
- Tap *OK*.
- Follow the further instructions given in the display.

The cleaning process is complete when rinsing has finished.

### Degreasing the brew unit and cleaning inside

Depending on the natural oil content of the coffee used, the brew unit can become blocked quite quickly. It must be degreased regularly in order to ensure aromatic coffee and trouble-free operation of the coffee machine.

For optimum cleaning we recommend Miele cleaning tablets. These cleaning tablets are specially designed for Miele built-in coffee machines and will protect your machine from subsequent damage.

They are available from the Miele Webstore, Miele Technical Service or from your Miele dealer.

The "Degrease brew unit" maintenance program lasts about 15 minutes.

After 200 portions have been dispensed, Degrease the brew unit and clean inside of the machine will appear in the display.

- Confirm the message with *OK*.

This notification appears at regular intervals. Once the maximum possible number of beverage preparations has been reached, the coffee machine is locked.

You can turn off the coffee machine if you do not want to carry out the cleaning program at this time. However, you will be not be able to make any more drinks until the brew unit has been degreased.

## Start "Degrease brew unit"

- Tap .
- Select Maintenance and tap OK.
- Select Degrease the brew unit.

The cleaning process cannot be cancelled once it has started. The process has to be completed through to the end.

- Tap OK.

The process will start.

- Follow the instructions in the display.

## Cleaning the brew unit and inside it

Clean the brew unit **by hand only** using warm water. Do **not** use liquid dish soap. The moving parts of the brew unit are lubricated. Liquid dish soap will damage the brew unit.

For good tasting coffee and to prevent germs from forming, remove and clean the brew unit under running water once a week.

Rinse the brew unit by hand and clean inside the machine appears on the display.

- Open the appliance door.

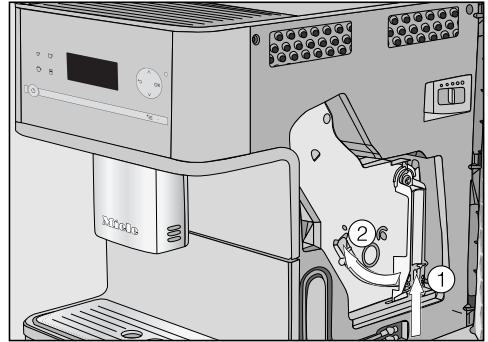

- Press the button on the end of the handle of the brew unit ① and while doing so turn the handle counter-clockwise ②.
- Carefully pull the brew unit out of the coffee machine.

If you cannot remove the brew unit or can only do so with difficulty, the brew unit is not in the correct position (See "Frequently asked questions").

When you have removed the brew unit, do **not** change the position of the handle on the brew unit.

- Clean the brew unit **by hand under hot running water** without using detergent or liquid dish soap.

## Cleaning and care

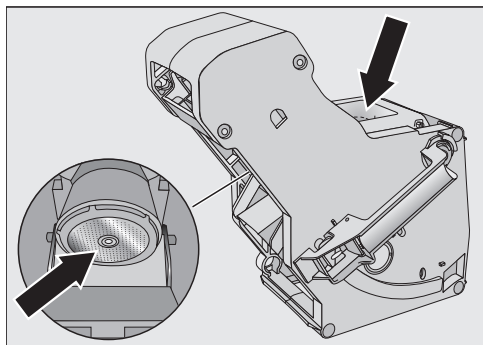

- Wipe any remaining coffee off the two filters (see arrows).
- Dry the funnel to prevent ground coffee sticking to it the next time a coffee is prepared.

Make sure to remove moist ground coffee remnants regularly to prevent bacteria from forming.

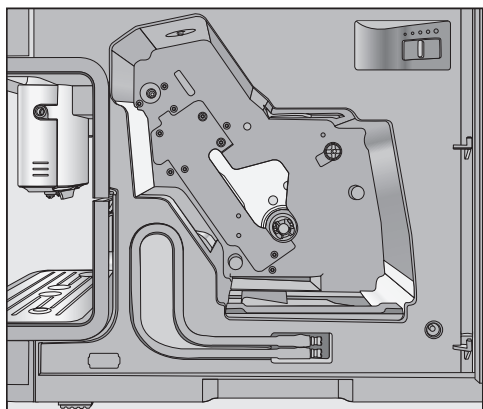

- Clean the inside of the coffee machine. Make sure that the areas highlighted in the illustration are cleaned extremely carefully.

**Tip:** Use your vacuum cleaner to remove dry coffee grounds.

Place a cleaning tablet in the brew unit, place it in the machine and close the machine door. **appears on the display.**

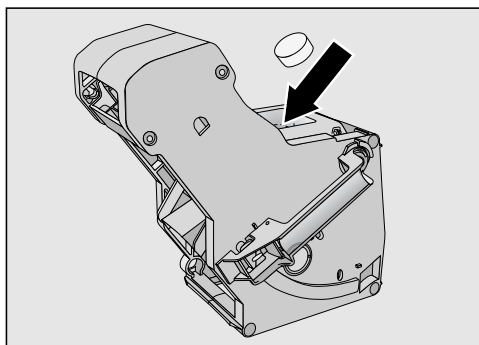

- Drop a cleaning tablet into the top of the brew unit (arrow).
- Push the brew unit with cleaning tablet back into the coffee machine, making sure it is straight.

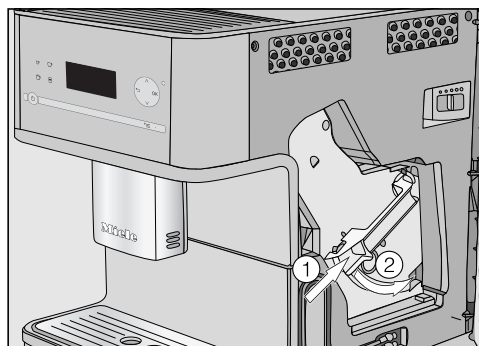

- Press the button on the end of the handle of the brew unit ① and while doing so turn the handle clockwise ②.
- Close the appliance door.
- Follow the further instructions given in the display.

The cleaning process is complete when rinsing has finished.

### **Degrease the brew unit following display reminder**

No drinks can be made and Degrease the brew unit appears in the display.

The maintenance program cannot be cancelled. The process has to be carried through to the end.

#### ■ Tap *OK*.

The maintenance program will then start.

# Descaling the machine

Important! When descaling the appliance, cover delicate surfaces and natural flooring to prevent damage from splashes of descaling solution. Ensure that any splashes of descaling solution are wiped up immediately.

Lime scale builds up in the coffee system through use. How often the appliance needs to be descaled will depend on the water hardness level in your area. It should be descaled regularly to ensure that it functions correctly.

The appliance will guide you through the descaling process. Various messages will appear in the display, e.g. you will be prompted to empty the drip tray or fill the water reservoir.

The descaling process is **required** and takes approx. 12 minutes.

The coffee machine prompts you when it needs to be descaled. "No. of portions until appliance needs descaling: No. of uses until appliance needs descaling: 50" appears in the display. Each time a drink is made the coffee machine displays the number of portions remaining until descaling must be carried out.

- Confirm the message with *OK*.

When the number of remaining portions reaches 0, the system will lock.

You can turn off the coffee machine if you do not want to descale it at this time. However, you will be not be able to make any more drinks until descaling has been carried out.

## Descaling following display reminder

Descal the appliance appears in the display.

The descaling process cannot be cancelled once you have tapped "OK." The process has to be completed through to the end.

- Tap *OK*.

The process will start.

- Follow the instructions in the display.

When Fill the water container with descaling agent and lukewarm water up to the descaling symbol  and place in appliance appears in the display, proceed as follows.

## Preparing the descaling solution

We recommend using Miele descaling tablets for optimum results.

These have been specially developed for use with Miele coffee machines and prevent subsequent damage.

Other descaling agents, which contain other acids besides citric acid and/or other undesirable substances, such as chlorides for example, could damage the coffee machine. Moreover, the descaling effect required may not be guaranteed if the descaling solution is not of the appropriate concentration.

Miele descaling tablets are available to order via the Miele Webstore, from Miele Service or from your Miele dealer.

You will need **1** descaling tablet to descale the appliance.



## Descaling the machine

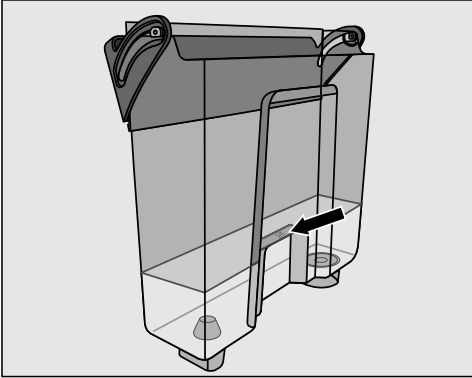

- Fill the water reservoir to the ☞ mark with lukewarm water.
- Place 1 descaling tablet in the water.

Follow the instructions for the mixing ratio carefully. It is important that you do not fill the water reservoir with too much or too little water. Otherwise the descaling process will be cancelled prematurely.

To protect the appliance and surrounding surfaces from damage, make sure you wipe up any spills or splashes of descaling agent immediately.

### Descaling when not prompted by a message

- Tap .
- Select Maintenance and tap *OK*.
- Select Descal the appliance.

The descaling process cannot be cancelled once you have tapped "OK." The process has to be completed through to the end.

- Tap *OK*.

The descaling process will begin.

### Performing a descale

- Replace the water reservoir.
- Follow the instructions given in the display.

**When** Rinse the water container and fill with fresh tap water up to the descaling symbol ☞ appears in the display:

- Carefully rinse the water reservoir with clean water. Ensure that **no** descaling solution residue remains in the water reservoir. Fill the water reservoir to the ☞ mark with fresh tap water.

The descaling program is finished at the end of the rinsing cycle and drinks can be made again.

## Frequently Asked Questions

---

Most problems that occur during daily use can be easily corrected. With the help of the following guide, you will be able to find the causes of problems and rectify them. However, please note:

 **Important!** Never open the casing of the appliance.  
Repairs and other work by unqualified persons could be dangerous. The manufacturer cannot be held responsible for unauthorized work.  
Repairs to electrical appliances should only be carried out by a suitably qualified person in accordance with local and national safety regulations.



If you cannot remedy the problem yourself, please contact Miele.

### Messages in the display



Fault messages must be confirmed with OK, otherwise the message can reappear in the display even though the problem has been remedied.

To address the fault, follow the instructions on the display.

If the fault message appears in the display again, contact Miele.

Message	Possible cause and solution
<b>F1, F2, F80, F82</b>	There is an internal fault. ■ Switch the coffee machine off with the On/Off button  . Wait for approx. one hour before switching it back on again.
<b>F41, F42, F74, F77, F235, F236</b>	There is an internal fault. ■ Turn the appliance off with the On / Off button  . Wait for 2 minutes before turning it back on again.
<b>F10, F17</b>	No water or very little water is being drawn in. ■ Remove the water container, fill it with fresh tap water and replace it. ■ Check the stainless steel water intake valve filter and clean if necessary (see "Stainless steel water intake valve filter").

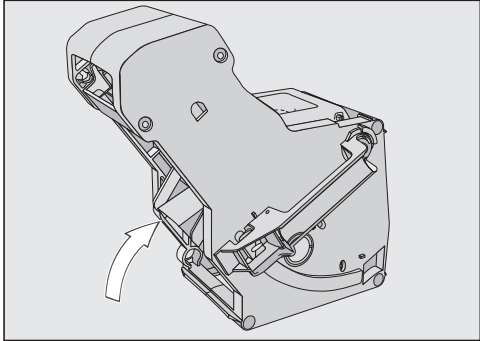
## Frequently Asked Questions



Message	Possible cause and solution
<p><b>F73 or</b> Check the brew unit</p>	<p>The brew unit cannot be positioned correctly.</p> <ul style="list-style-type: none"><li>■ Turn the appliance off with the On / Off  button.</li><li>■ Remove and clean the brew unit (see "Removing the brew unit and cleaning it by hand").</li></ul>  <ul style="list-style-type: none"><li>■ Push the coffee ejector of the brew unit into the correct position (see diagram).</li><li>■ Do not insert the brew unit. Close the appliance door and turn the appliance on with the On/Off button .</li></ul> <p>This will initialize the brew unit motor and put in back into the start position.</p> <ul style="list-style-type: none"><li>■ When Insert the brew unit appears in the display, open the appliance door and put the brew unit back in the appliance. Then close the door.</li></ul>

## Frequently Asked Questions



---

Message	Possible cause and solution
Too much ground coffee	<p>There is too much ground coffee in the coffee chute. If more than two level scoops of ground coffee is added to the coffee chute, the brew unit cannot process the coffee. The ground coffee will be directed into the waste unit and the fault message will appear in the display.</p> <ul style="list-style-type: none"><li>■ Turn the appliance off with the On / Off  button.</li><li>■ Remove and clean the brew unit (see "Removing the brew unit and cleaning it by hand").</li><li>■ Remove the ground coffee inside the coffee system, e.g. with a vacuum cleaner.</li><li>■ Use the coffee scoop supplied to add ground coffee to the ground coffee chute. Add only a maximum of <b>two</b> portions of ground coffee to the chute.</li></ul>

## Unusual performance of the coffee system

Problem	Possible cause and solution
<p><b>The display remains dark when the coffee system is turned on using the On / Off  button.</b></p>	<p>The On / Off  button was not touched for long enough.</p> <ul style="list-style-type: none"> <li>■ Touch the On / Off button  and keep it pressed for at least three seconds.</li> </ul>
	<p>The plug is not properly plugged into the electrical outlet.</p> <ul style="list-style-type: none"> <li>■ Insert the plug into the electrical outlet.</li> </ul>
	<p>The fuse has tripped because the coffee system, voltage or another appliance is defective.</p> <ul style="list-style-type: none"> <li>■ Unplug the power cord from the electrical outlet.</li> <li>■ Contact a qualified electrician or Miele Technical Service for assistance.</li> </ul>
<p><b>CM 6350: The lighting remains off after the coffee machine has been turned on.</b></p>	<p>The lighting has been turned off.</p> <ul style="list-style-type: none"> <li>■ Turn the lighting on (see "Settings - Lighting").</li> </ul>
	<p>The lamp is defective.</p> <ul style="list-style-type: none"> <li>■ Contact Miele Technical Service.</li> </ul>
<p><b>The coffee system turns off suddenly.</b></p>	<p>The switch-off time programmed using the timer has been reached.</p> <ul style="list-style-type: none"> <li>■ If required, you can select a new switch-off time (see "Settings - Timer").</li> </ul>
	<p>The plug is not properly plugged into the electrical outlet.</p> <ul style="list-style-type: none"> <li>■ Insert the plug into the electrical outlet.</li> </ul>
<p><b>CM 6350: The coffee machine is switched on. The lighting switches off suddenly.</b></p>	<p>This is not a fault. The lighting turns off approximately 7 minutes after the coffee machine was last used.</p>
<p><b>The sensor buttons do not respond. The machine can no longer be operated.</b></p>	<p>There is an internal fault.</p> <ul style="list-style-type: none"> <li>■ Disconnect power by unplugging the power cord from the electrical outlet and or switching off the circuit breaker.</li> </ul>

## Frequently Asked Questions

Problem	Possible cause and solution
<p><b>The coffee system does not switch itself on, although the timer setting Turn on at has been activated.</b></p>	<p>The system lock feature has been activated.</p> <ul style="list-style-type: none"> <li>■ You need to deactivate the system lock (see "Settings - System lock").</li> </ul> <p>The appliance was not used after being switched on automatically three times in succession.</p> <ul style="list-style-type: none"> <li>■ Switch the appliance on and dispense a drink.</li> </ul>
<p><b>The display is hard to see or not legible.</b></p>	<p>The display brightness has been set too low.</p> <ul style="list-style-type: none"> <li>■ Change this setting (see "Settings").</li> </ul>
<p>Fill and replace the water container <b>appears in the display even though the water container is full and is in the appliance.</b></p>	<p>The water container is not sitting properly in the appliance.</p> <ul style="list-style-type: none"> <li>■ Remove the water container and replace it.</li> <li>■ Check the stainless steel water intake valve filter and clean if necessary (see "Stainless steel water intake valve filter").</li> </ul> <p>The water container was not correctly filled up and inserted during descaling.</p> <ul style="list-style-type: none"> <li>■ Fill the water container to the descaling mark  and restart the descaling program.</li> </ul>
<p>Fill and replace the water container <b>appears after switching on even though the container is filled and fitted in the appliance. The appliance does not rinse.</b></p>	<p>The coffee system needs to be descaled.</p> <ul style="list-style-type: none"> <li>■ Turn the coffee system off with the On / Off button . Wait approx. 1 hour.</li> <li>■ Then switch the appliance on again. As soon as PreHeating appears in the display, tap  and select Descale the appliance.</li> <li>■ Descale the coffee system.</li> </ul>
<p><b>After switching on the appliance the message Empty the drip tray and the waste container appears even though they are both empty.</b></p>	<p>This is not a fault.</p> <p>The drip tray and grounds container was probably not emptied after making the last coffee, or the internal counter was not reset.</p> <ul style="list-style-type: none"> <li>■ Remove the drip tray and grounds container from the appliance and empty them.</li> </ul>
<p><b>Neither milk nor milk froth comes out of the central spout.</b></p>	<p>The milk pipework is blocked.</p> <ul style="list-style-type: none"> <li>■ Clean the main dispenser, taking particular care to clean the cappuccinatore and milk pipes carefully with the cleaning brush.</li> </ul>

## Frequently Asked Questions

Problem	Possible cause and solution
Empty the drip tray and the waste container <b>appears in the display, even though the drip tray is empty.</b>	<p>The drip tray is not positioned correctly in the appliance.</p> <ul style="list-style-type: none"> <li>■ Push the drip tray in as far as it will go.</li> <li>■ Make sure that the lower panel is sitting on the drip tray correctly.</li> </ul>
Insert the drip tray and the waste container <b>appears in the display even though both are fitted.</b>	<p>The drip tray is not correctly fitted and is therefore not detected.</p> <ul style="list-style-type: none"> <li>■ Empty the drip tray and the grounds container. Reassemble all parts and place the drip tray and the grounds container back in the coffee system.</li> </ul>
	<p>The service is open.</p> <ul style="list-style-type: none"> <li>■ Close the service door.</li> <li>■ If necessary, empty the drip tray and the grounds container. Reassemble all parts and place the drip tray and the grounds container back in the coffee system.</li> </ul>
<b>The drip tray or the grounds container is too full or runs over although the drip tray and the grounds container were emptied after each message on the display.</b>	<p>This is not a fault.</p> <p>The drip tray and grounds container were probably removed or the appliance was opened without the drip tray and grounds container being emptied. When the drip tray is removed or the appliance opened, the internal counter for emptying the drip tray and grounds container is automatically reset.</p> <ul style="list-style-type: none"> <li>■ Remove the drip tray and grounds container from the appliance and empty them.</li> </ul>
Fill the bean container <b>appears in the display even though the bean container has just been filled.</b>	<p>This is not a fault.</p> <ul style="list-style-type: none"> <li>■ Confirm the message with <i>OK</i>.</li> </ul>
<b>The coffee system does not rinse itself when turned on.</b>	<p>This is not a fault.</p> <p>If the coffee system still has an operating temperature higher than 140°F (60°C), rinsing will not take place.</p>

## Frequently Asked Questions

Problem	Possible cause and solution
<p><b>Coffee dispensing is repeatedly interrupted and the message <small>Fill the bean container</small> appears in the display.</b></p>	<p>This is not a fault. The brew unit does not sense the ground coffee. With particular types of coffee, it can happen that too little coffee is ground or the ground coffee is too fine. Usually the grinding – fine and the ground coffee quantity – are set too low.</p> <ul style="list-style-type: none"> <li>■ Confirm the message with <i>OK</i>.</li> </ul> <p>Tip: If the coffee is too strong for you or it tastes bitter, try another type of bean.</p> <p>If the message appears during the preparation of all coffee specialties:</p> <ul style="list-style-type: none"> <li>■ Set the grinder to a coarser setting (see "Grinder setting").</li> <li>■ Check the settings for the amount of coffee for all coffee specialties (see "Amount of coffee"). If necessary, select a larger amount of coffee.</li> </ul> <p>Also consider any changed drinks in "User profiles" ●.</p> <p>If the message only appears during the preparation of selected coffee specialties:</p> <ul style="list-style-type: none"> <li>■ Check the settings for the amount of coffee for this coffee specialty (see "Amount of coffee"). Select a amount of coffee.</li> <li>■ You may also need to set a slightly coarser grinder setting.</li> </ul>
<p><b>The descaling program was started unintentionally.</b></p>	<p>The descaling program cannot be stopped once the OK button has been tapped. Descaling must be continued through to completion. This is a safety precaution to make sure the machine is descaled correctly. This is important for the longevity and functional efficiency of your coffee system.</p> <ul style="list-style-type: none"> <li>■ Descal the coffee system (see "Descaling").</li> </ul>



## Frequently Asked Questions

Problem	Possible cause and solution
<b>Coffee is not flowing out of the central spout, or is only being dispensed via one spout.</b>	<p>The main dispenser has a blockage.</p> <ul style="list-style-type: none"><li>■ Clean the coffee pipework (see "Cleaning and care - Rinsing the machine").</li></ul> <p>If there is still no coffee coming out, or coffee is only coming out of one side</p> <ul style="list-style-type: none"><li>■ Dismantle the main dispenser and clean all parts carefully (see "Cleaning and care - Main dispenser with integrated cappuccinatore").</li><li>■ Make sure all parts are reassembled correctly.</li></ul>
<b>Milk is dripping out of the cappuccinatore even though no milk is being dispensed.</b>	<p>The level of milk in the milk flask is higher than the cappuccinatore.</p> <ul style="list-style-type: none"><li>■ Push the main dispenser up as far as it will go.</li></ul>

## Frequently Asked Questions

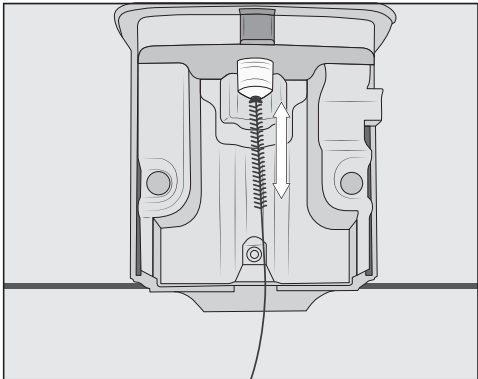
Problem	Possible cause and solution
<p><b>The milk sputters when it is dispensed. Hissing noises can be heard when milk is being heated up or frothed. Although the milk should be frothed, only hot milk is comes out of the main dispenser.</b></p>	<p>The milk temperature is too high. Good milk froth can only be achieved when cold milk (below 50°F/10°C) is used.</p> <ul style="list-style-type: none"> <li>■ Check the temperature of the milk.</li> </ul> <p>The main dispenser with integrated cappuccinatore is not correctly fitted and is taking in air. Or the spouts are blocked.</p> <ul style="list-style-type: none"> <li>■ Check whether the main dispenser is correctly assembled. Make sure that all parts are tightly connected to one another.</li> <li>■ If necessary, clean the main dispenser. Rub the spout under running water to remove any dirt.</li> </ul> <p>The milk pipework, connections or the intake tube on the milk flask are blocked.</p> <ul style="list-style-type: none"> <li>■ Clean all parts carefully with the cleaning brush.</li> </ul> <p>The steam jet on the main dispenser has a blockage.</p>  <ul style="list-style-type: none"> <li>■ Clean the steam jet with the cleaning brush (see illustration).</li> </ul>
<p><b>Coffee grounds have settled on the lid of the drip tray and in the interior around the brew unit.</b></p>	<p>This does not indicate a fault. The movement of the brew unit during the brewing process can cause some ground coffee to fall around it. The type of beans used, the fineness of the ground coffee and the amount of coffee ground also affect the amount. Important! Clean the inside of the brew unit regularly to prevent mold and the like.</p>

## Frequently Asked Questions

Problem	Possible cause and solution
<p><b>The display lights up but the coffee machine does not heat up and no drinks are made.</b></p> <p><b>The coffee machine cannot be turned off with the On/Off button .</b></p>	<p>The Demo mode of the coffee system has been activated.</p> <ul style="list-style-type: none"><li>■ Deactivate the Demo mode (see "Settings - Demo mode").</li></ul>

# Frequently Asked Questions

## Unsatisfactory results

Problem	Possible cause and solution
<p><b>The coffee is not hot enough.</b></p>	<p>The cup has not been pre-heated. The smaller the cup and the thicker its walls, the more important it is to pre-heat it.</p> <ul style="list-style-type: none"> <li>■ Pre-heat the cups, e.g. using the cup heating (according to model).</li> </ul>
	<p>The brewing temperature is set too low.</p> <ul style="list-style-type: none"> <li>■ Set a higher brewing temperature (see "Brewing temperature").</li> </ul>
	<p>The brew unit filters are blocked.</p> <ul style="list-style-type: none"> <li>■ Remove and clean the brew unit by hand (see "Removing the brew unit and cleaning it by hand").</li> <li>■ Degrease the brew unit (see "Brew unit").</li> </ul>
<p><b>Heating-up is taking longer. The amount of water is no longer correct and the coffee machine is not performing properly. Coffee flows into the cup very slowly.</b></p>	<p>The coffee machine needs to be descaled.</p> <ul style="list-style-type: none"> <li>■ Descale the coffee machine.</li> </ul>
<p><b>The amount of coffee or espresso dispensed has changed.</b></p>	<p>This is not a fault. You probably changed the drink size by pressing the sensor longer. Touching the drink buttons for longer starts quantity programming for the respective drink ("Portion size"). If you do not save a portion size, the maximum possible amount is saved for this drink.</p>
<p><b>The consistency of the milk froth is unsatisfactory.</b></p>	<p>The milk temperature is too high. Good milk froth can be achieved when cold milk (&lt; 50°F/10°C) is used.</p> <ul style="list-style-type: none"> <li>■ Check the temperature of the milk in the milk flask.</li> </ul>
	<p>The milk pipework is blocked.</p> <ul style="list-style-type: none"> <li>■ Clean the central spout with integrated cappuccinatore and the milk pipework with the cleaning brush supplied.</li> </ul>

## Frequently Asked Questions

Problem	Possible cause and solution
<p><b>The coffee grinder makes a louder noise than usual.</b></p>	<p>The coffee bean container has become empty during the grinding process.</p> <ul style="list-style-type: none"> <li>■ Fill the coffee bean container with fresh beans.</li> </ul>
	<p>There may be stones in among the coffee beans.</p> <ul style="list-style-type: none"> <li>■ Turn the coffee system off immediately. Contact Miele.</li> </ul>
<p><b>The coffee flows too quickly into the cup.</b></p>	<p>The grind level is too coarse.</p> <ul style="list-style-type: none"> <li>■ Set the grinder to a finer setting (see "Setting the coffee grinder").</li> </ul>
<p><b>The coffee trickles too slowly into the cup.</b></p>	<p>The grind level is too fine.</p> <ul style="list-style-type: none"> <li>■ Set the grinder to a coarser setting (see "Grinder setting").</li> </ul>
<p><b>The crema on the coffee or espresso is "not right".</b></p>	<p>The grinder setting is not correct.</p> <ul style="list-style-type: none"> <li>■ Set the grinder to a finer or coarser setting (see "Grinder setting").</li> </ul>
	<p>The brew temperature is too high for the type of coffee being used.</p> <ul style="list-style-type: none"> <li>■ Set a lower brewing temperature (see "Brewing temperature").</li> </ul>
	<p>The coffee beans are no longer fresh.</p> <ul style="list-style-type: none"> <li>■ Add fresh beans to the coffee bean container.</li> </ul>

# Transport

---



If the coffee system will not be used for an extended period of time, e.g. vacation, or will be transported over a long distance, the appliance should be prepared as follows.

- Empty and clean the coffee bean container
- Empty and clean the water reservoir
- Evaporating the coffee system
- Clean the drip tray and grounds container
- Pack the appliance securely

## Evaporating the coffee system

The coffee system should be evaporated before it is stored for a long period of time or transported any distance - particularly at temperatures below freezing.

Evaporating means removing all water from the system. This prevents water and frost damage in the unit.

- Turn the coffee system off with the On / Off button .
- Tap .
- Tap  twice.

Empty the system? appears on the display.

- Select **Yes** and tap **OK**.
- Follow the instructions on the display.

 **Caution!** Danger of burning and scalding at the dispensers. Hot steam is discharged.

The evaporation process is finished when **Program finished** appears on the display and the display then goes out.

- Switch off the machine and unplug the power cord from the electrical outlet to disconnect it.
- Clean the drip tray and grounds container.

The coffee system is now ready to be packed.

## Packaging

The coffee system should only be packed when it is clean and dry. Residues of coffee grounds can cause scratches on surfaces. Coffee and milk residues or water can cause a build-up of bacteria.

Use the original packaging including Styrofoam to pack the coffee system.

Also pack the operating instructions so that they are available when the coffee system is next used.

## After sales service

In the event of a fault that you cannot correct yourself, please contact

- Your Miele dealer
- or
- Miele Technical Service

The telephone number for Miele is listed at the back of these instructions.

Miele Technical Service requires the **model** and **serial number** of your coffee machine.

This information can be found on the data plate:

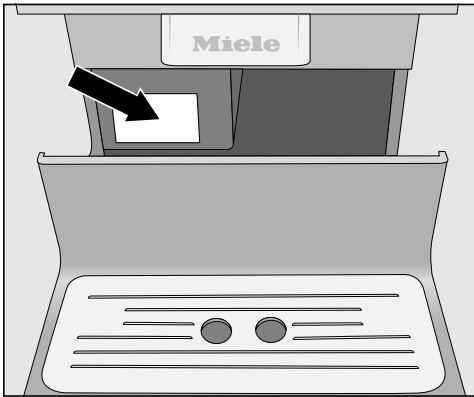

## Warranty

For more information, please refer to the included warranty.

### MieleCare (USA only)

**MieleCare**, our Extended Service Contract program, gives you the assurance of knowing that your appliance investment is covered by 5 years of worry free ownership.

**MieleCare** is the only Extended Service Contract in the industry that guarantees repairs by a Miele Authorized Service Provider using genuine Miele parts. Only genuine Miele parts installed by factory trained professionals can guarantee the safety, reliability, and longevity of your Miele appliance. Please note that unless expressly approved in writing by Miele's Service department, Extended Service Contracts offered by other providers for Miele products will not be recognized by Miele. Our goal is to prevent unauthorized (and untrained) service personnel from working on your Miele products, possibly doing further damage to them, you and/or your home.

To learn more about **MieleCare** Extended Service Contracts, please contact your appliance dealer or visit us online at:

<http://mieleusa.com>

# Saving energy

---

**The following tips can help you save energy and money as well as help the environment:**

- Operate the coffee machine in "Eco mode" (pre-set).
- Energy consumption may increase if you change the settings for the "timers".

This setting uses more energy **appears on the display.**

- Switch the coffee machine off with the On/Off button  when it is not in use.
- Change the setting for the "Switch off after" timer to 15 minutes. Then the coffee machine will switch off 15 minutes after the last drink has been made or a sensor button has been touched.
- If you only want to pre-heat your cups occasionally, you can switch cup heating off (CM 6350). You can then use hot water to pre-heat the cups.



All electrical work should be performed by a qualified electrician in strict accordance with national and local safety regulations. Installation, repairs and other work by unqualified persons could be dangerous.

Verify that the voltage, load and circuit rating information found on the data plate match the household electrical supply. This data must match to prevent damage to the coffee system. If in doubt, consult a licensed electrician.

The data plate can be found behind the drip tray inside the coffee system.

The appliance is supplied with a power cable ready for connection to an AC 120 V 60 Hz supply.

Connect the coffee system only to a properly installed outlet with grounding contact.

Fuse rating must be at least 15 A.

The socket should be next to the appliance and easily accessible.

To reduce the risk of injury, do not drape cord over the counter top or table top where it can be pulled on by children or tripped over unintentionally.

Do not connect the appliance to a power inverter or directly to power produced outside of the normal electrical grid (i.e. direct solar or wind power source).

Direct connection to such power sources can cause power surges and tripped breakers when the appliance is turned on, and could damage the appliance.

Do not connect the appliance to energy saving plugs or outlets. The reduction of power to the appliance caused by these devices will cause the appliance to run hot and may damage it and/or shorten its usable life.

Do not operate any appliance with a damaged cord or plug. Contact Miele Technical Service.

If there is any question concerning the electrical connection of this appliance to your power supply, please consult a licensed electrician or contact Miele's Technical Service Department.

**WARNING: THIS APPLIANCE MUST BE GROUNDED**

# Installation

## Danger of overheating!

Please ensure that there is adequate ventilation around the appliance.

Do not cover the appliance with dish towels or similar objects while it is in use.

## Danger of overheating

If the coffee machine is installed behind a kitchen furniture door, it may only be used with the furniture door open.

Do not close the furniture door while the coffee machine is in use.

Please observe the following installation instructions:

- The location of the appliance must be dry and well ventilated.
- The ambient temperature of the room in which the appliance is used must be between +50°F and +100°F (+10°C and +38°C).
- The coffee system must be set up on a level surface. The surface must be water resistant.

If the coffee system is installed in a niche, the niche must provide the following minimum dimensions:

Height	20"	508 mm
Width	17 11/16"	450 mm
Depth	21 7/8"	555 mm

When setting up the appliance: make sure that the front of the appliance can be fully opened so that the brew unit can be removed with ease when required.

- The appliance must be set up in the niche such that it sits flush with the front edge of the niche.

## Appliance dimensions

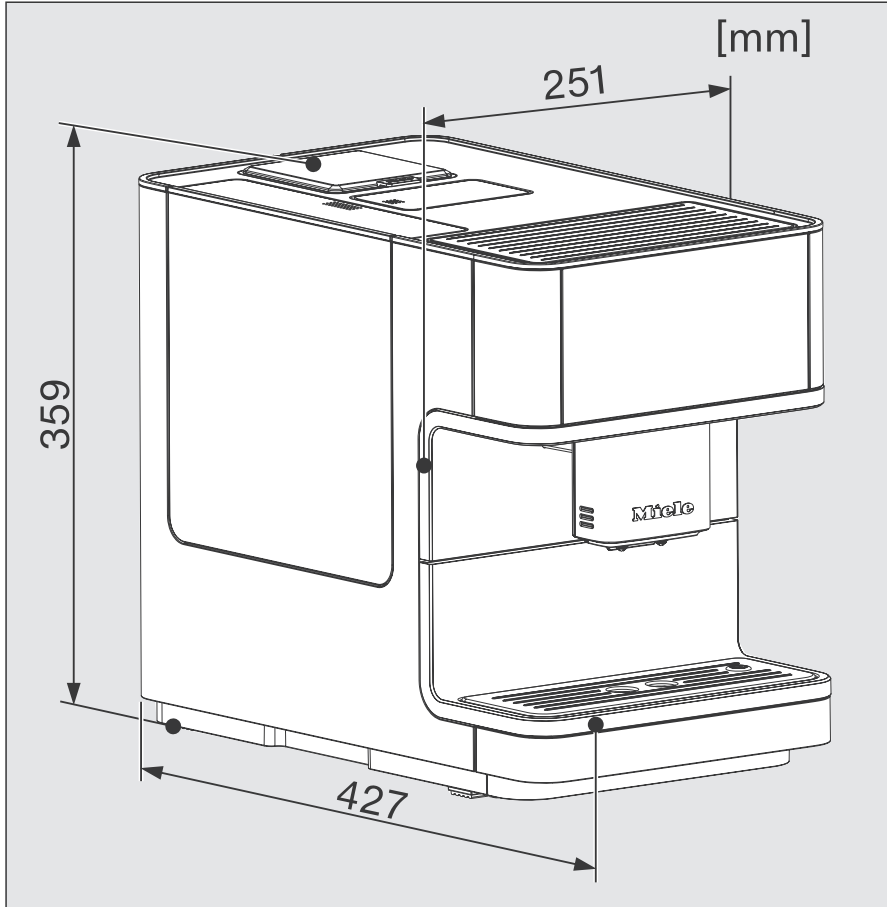

# Appliance dimensions

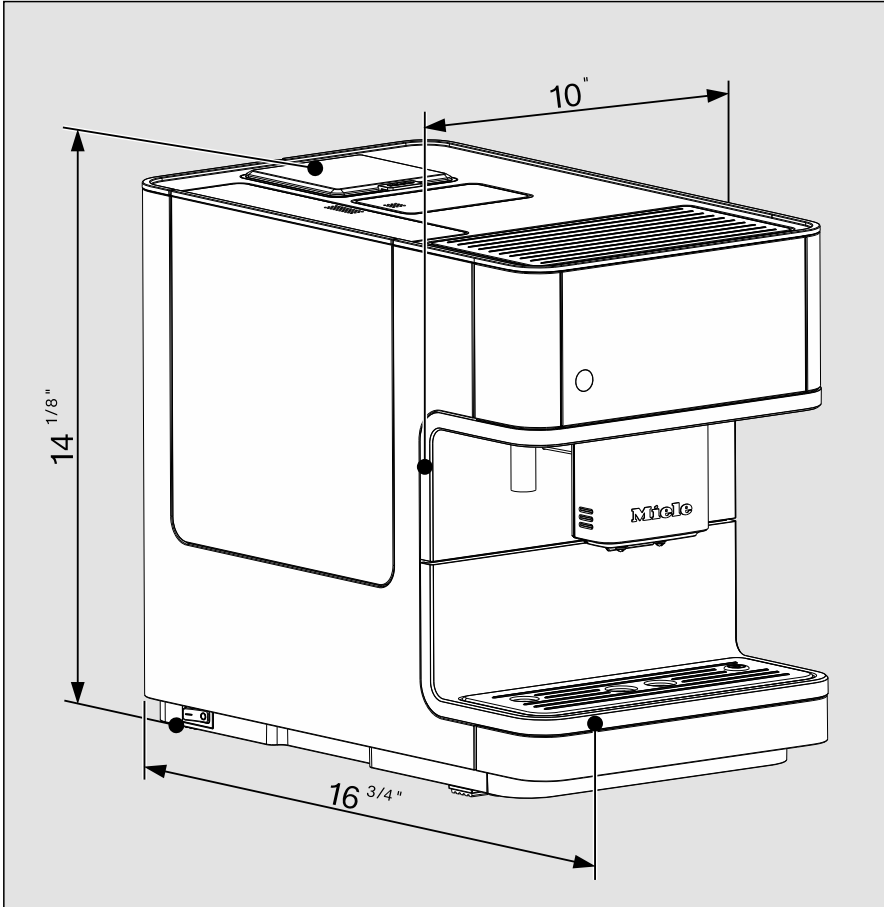

## Technical data

Current draw in standby mode (default setting):	<0.5 watt
Pump pressure:	max. 217 psi (15 bar)
Through-flow heater:	1 stainless steel thermo block
Dimensions (W x H x D):	10" x 14 1/8" x 16 3/4" (251 x 359 x 427mm)
Net weight:	22 lbs (9.9 kg)
Power cord length:	4' 7" (140 cm)
Water reservoir capacity:	approx. 7 1/2 cups (1.8 l)
Bean container capacity:	approx. 0.6 lbs (300 g)
Stainless steel milk flask capacity*:	approx. 2 1/2 cups (0.5 l)
Grounds container capacity:	max. 10 portions of coffee grounds
Main dispenser:	Height adjustable from 3 1/8"-5 1/2" (80-140 mm)
Grinder:	Stainless steel mill
Grinder setting:	Adjustable in 5 settings
Ground coffee amount:	max. approx. 0.4 ounces (12 g)



Please have the model and serial number  
of your appliance available when  
contacting Technical Service.

---

The Miele logo consists of the word "Miele" in a bold, white, serif font, set against a solid black rectangular background.

## **U.S.A.**

**Miele, Inc.**

### **National Headquarters**

9 Independence Way  
Princeton, NJ 08540  
Phone: 800-843-7231  
Fax: 609-419-4298  
[www.mieleusa.com](http://www.mieleusa.com)

### **Technical Service & Support**

Phone: 800-999-1360  
Fax: 888-586-8056  
[TechnicalService@mieleusa.com](mailto:TechnicalService@mieleusa.com)

### **International Headquarters**

Miele & Cie. KG  
Carl-Miele-Straße 29  
33332 Gütersloh  
Germany

## **Canada**

**Importer**  
**Miele Limited**

### **Headquarters and Miele Centre**

161 Four Valley Drive  
Vaughan, ON L4K 4V8  
[www.miele.ca](http://www.miele.ca)

### **Customer Care Centre**

Phone: 800-565-6435  
905-532-2272  
[customercare@miele.ca](mailto:customercare@miele.ca)

CM6150, CM6350



en – US, CA

M.-Nr. 10 685 710 / 00